

## ●PC200



PC200 - (AS06050)

Apparechiatura elettronica  
DISEGNI E SCHEMI

Electronic control unit  
DRAWINGS AND DIAGRAMS

## INSTALLAZIONE APPARECCHIATURA / CONTROL BOARD INSTALLATION

1

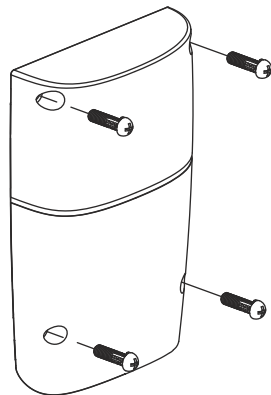
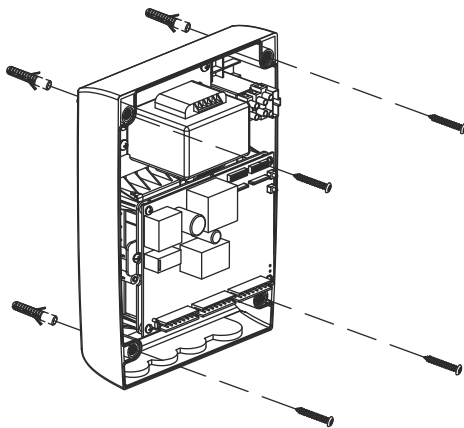
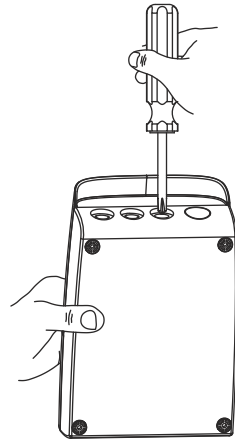
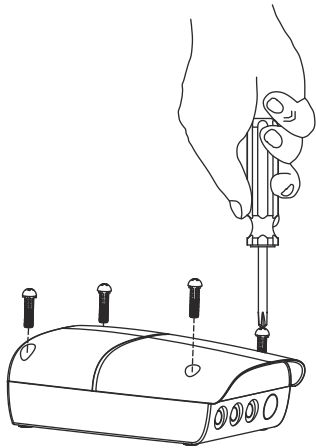

SCHEMA ELETTRICO / ELECTRICAL CONNECTIONS

2

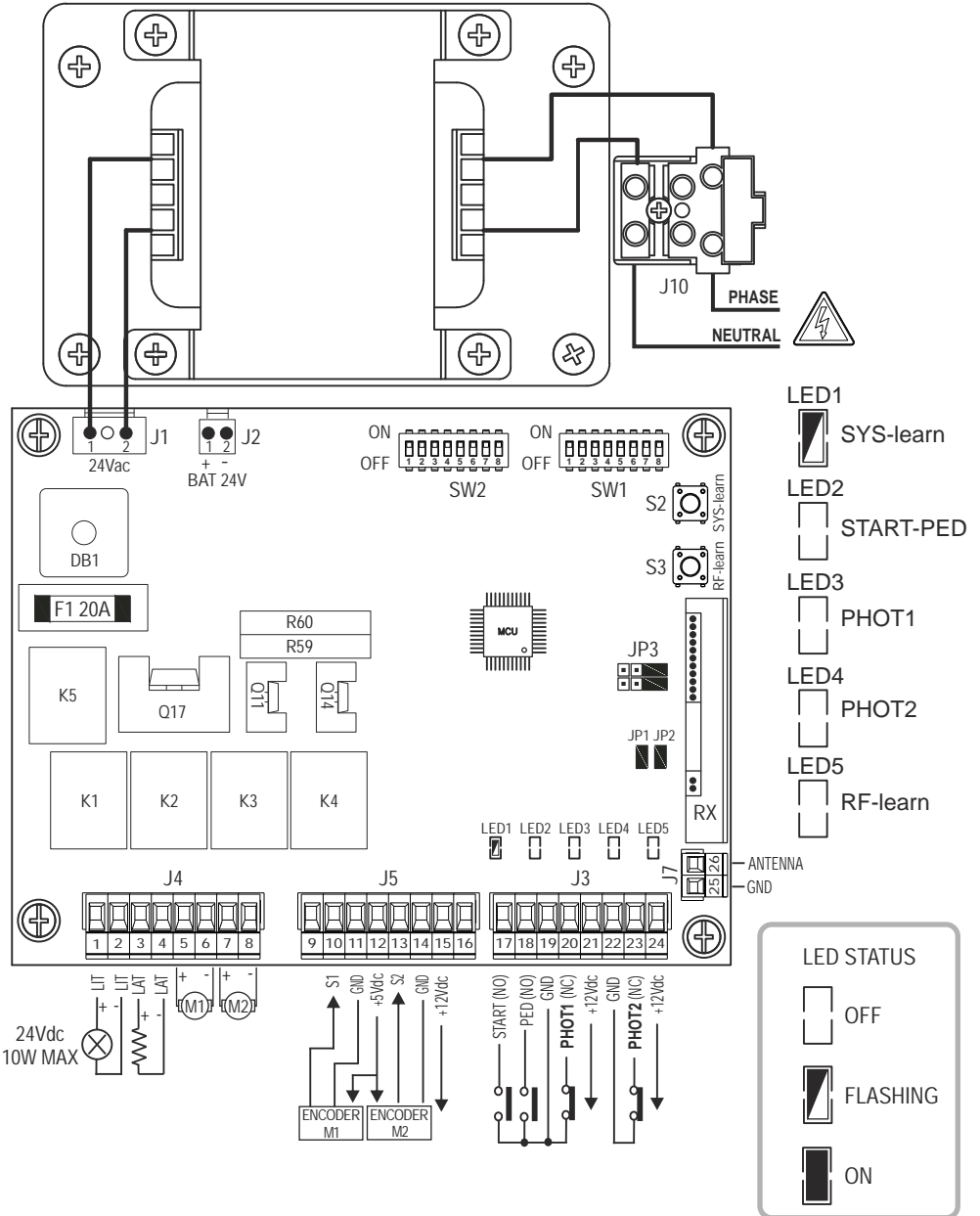

## COLLEGAMENTO ALIMENTAZIONE / POWER SUPPLY CONNECTION

3

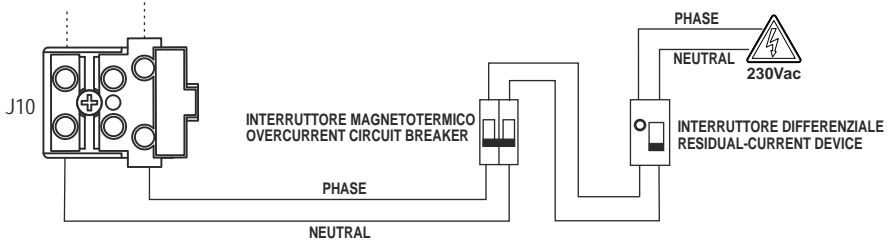

## COLLEGAMENTO MOTORE / MOTOR CONNECTION

4

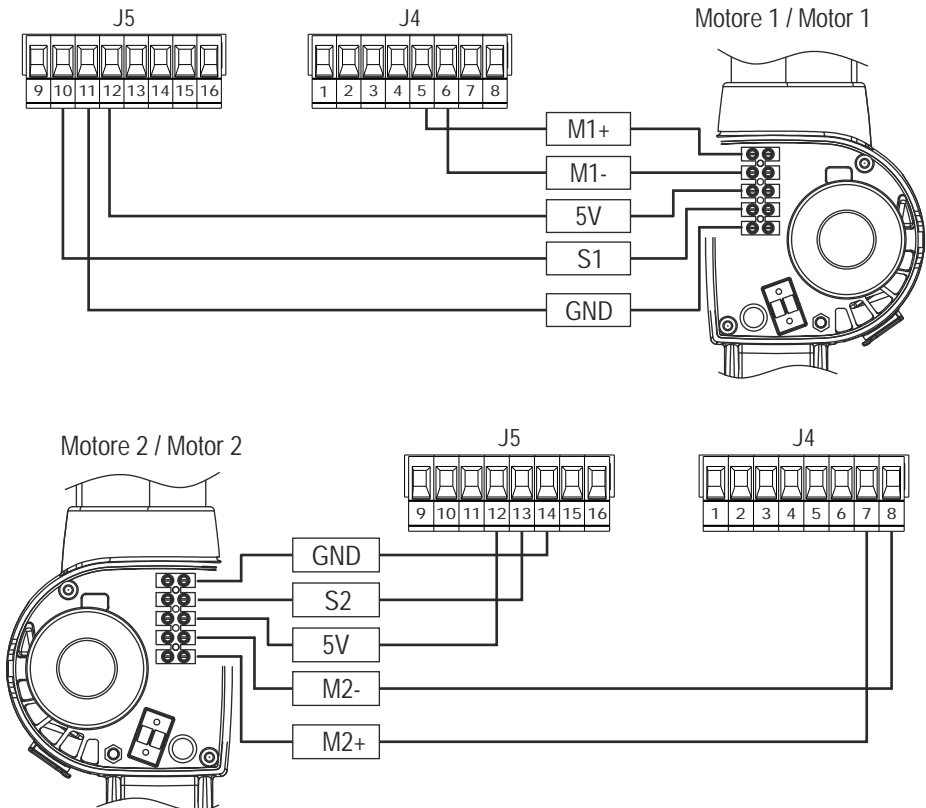

COLLEGAMENTO LAMPEGGIANTE / FLASHING LIGHT CONNECTION

5

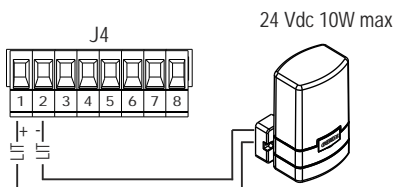

COLLEGAMENTO ELETTROSERRATURA / ELECTRIC LOCK CONNECTION

6

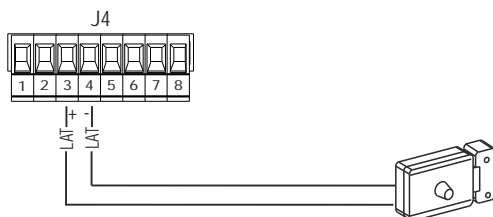

COLLEGAMENTO DISPOSITIVI DI COMANDO / CONTROL DEVICES CONNECTION

7

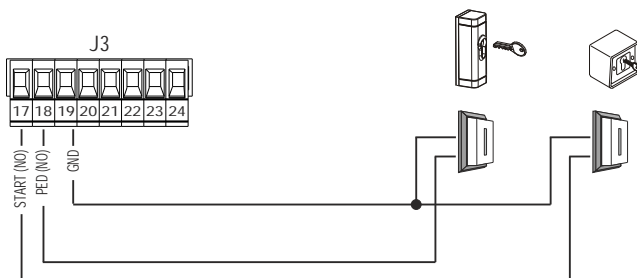

## DIP SWITCH SW2\_1-2

8

CONSULTARE IL MANUALE DELLE FOTOCELLULE PER MAGGIORI DETTAGLI / REFER TO THE PHOTOCELLS MANUAL FOR DETAILED CONNECTION DIAGRAMS

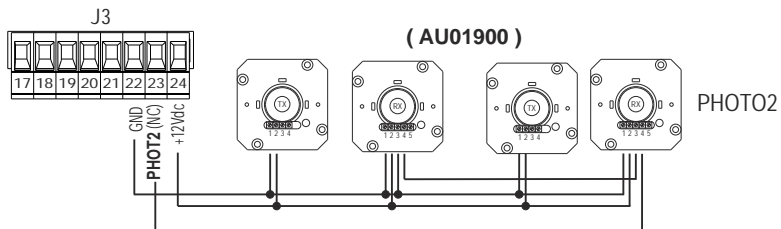
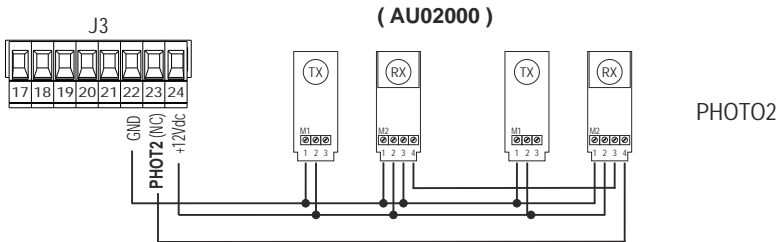
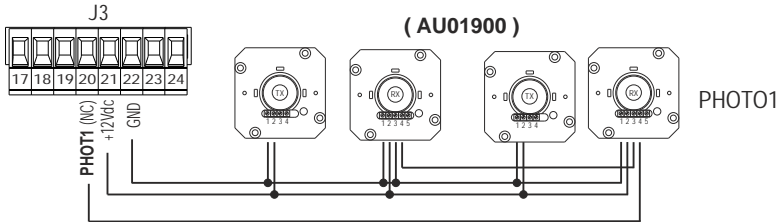
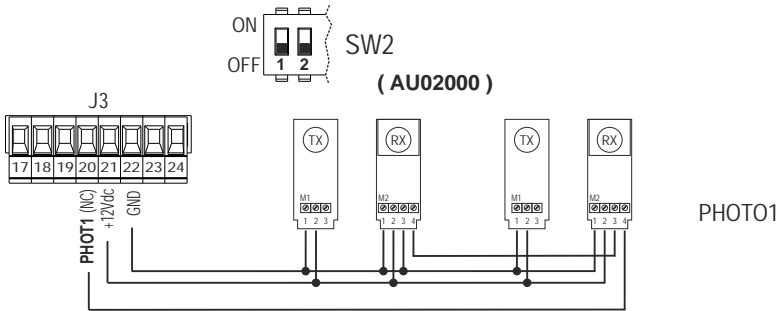

DIP SWITCH SW2\_1-2

9

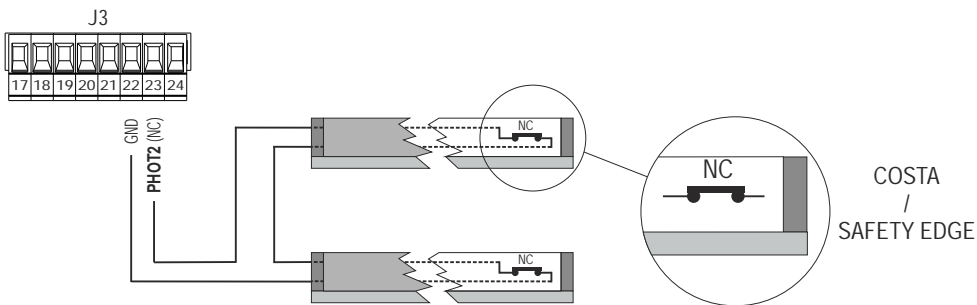
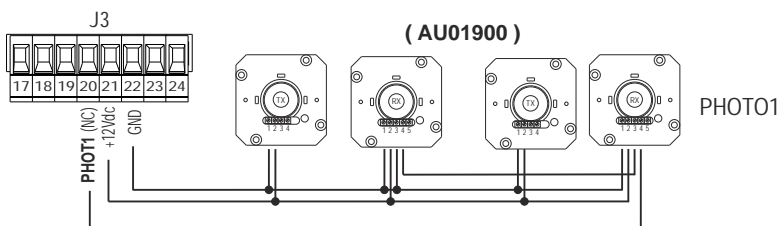
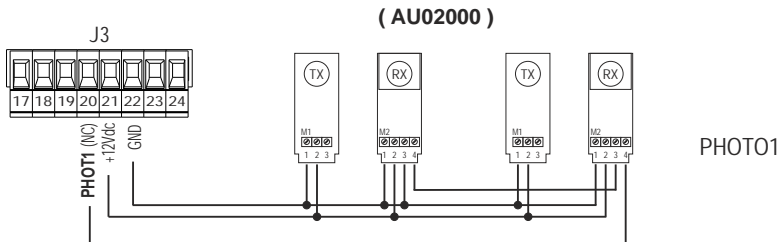
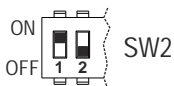

## DIP SWITCH SW2\_1-2

10

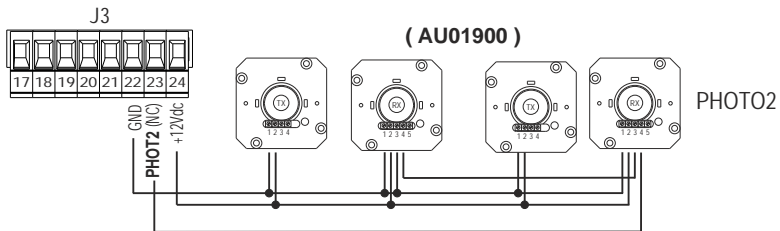
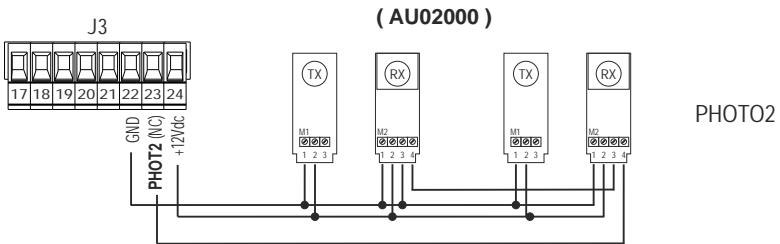
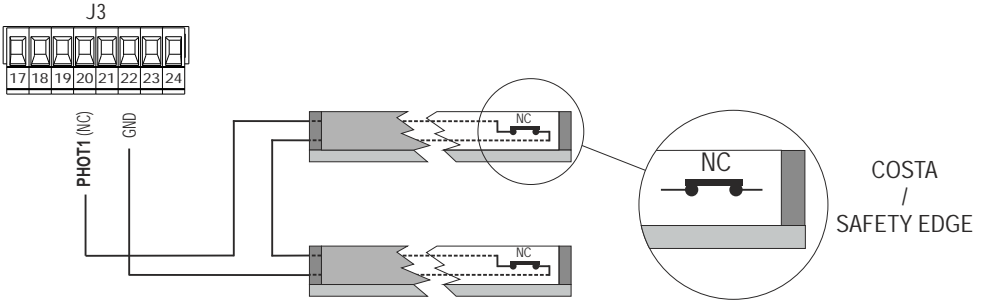
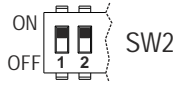



DIP SWITCH SW2\_1-2

11

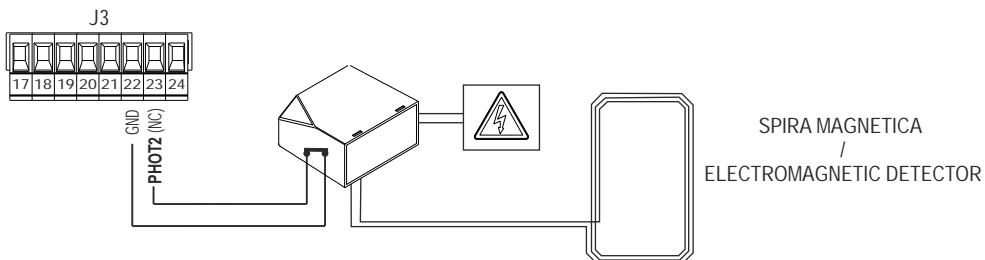
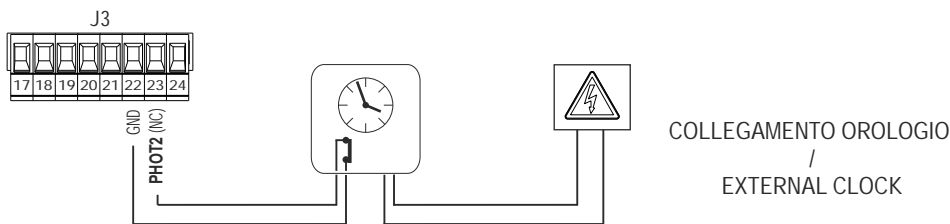
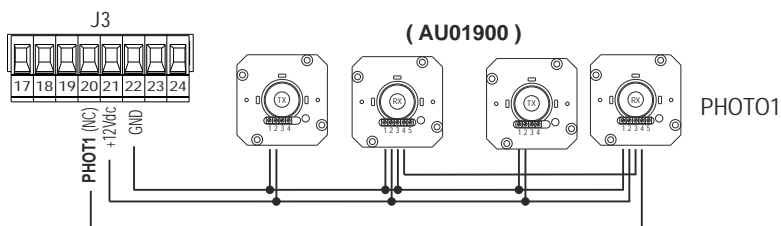
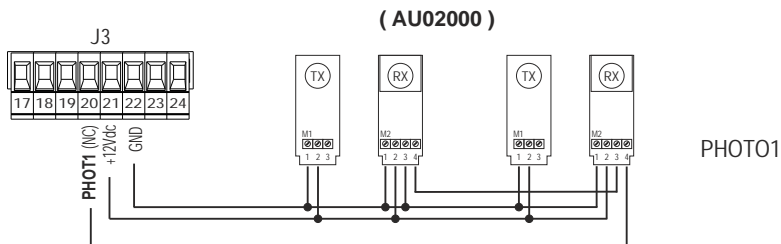
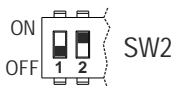

## ESEMPI IMPOSTAZIONE TASTI RADIOCOMANDO / TRANSMITTER BUTTONS SET UP EXAMPLES

12

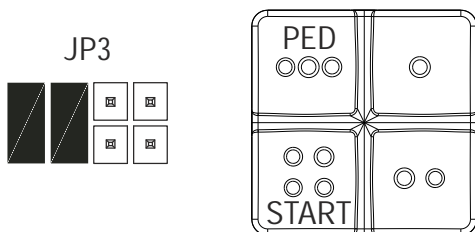
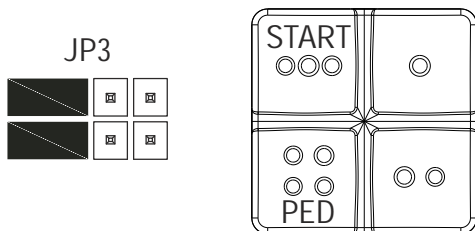
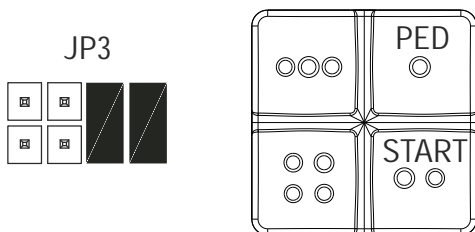
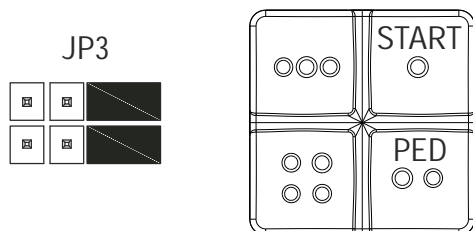



# GIBIDI

**GI.BI.DI. S.r.l.**

Via Abetone Brennero, 177/B  
46025 Poggio Rusco (MN) - ITALY  
Tel. +39.0386.52.20.11  
Fax +39.0386.52.20.31  
E-mail: [info@gibidi.com](mailto:info@gibidi.com)

Numero Verde: 800.290156

[www.gibidi.com](http://www.gibidi.com)

