

:SC

CE

SC230 (AS05710-AS05711)

Apparechiatura elettronica
SCHEMA ELETTRICO E COLLEGAMENTI

Electronic control unit
ELECTRICAL CONNECTIONS

I-UK

SCHEMA ELETTRICO / ELECTRICAL CONNECTIONS

1

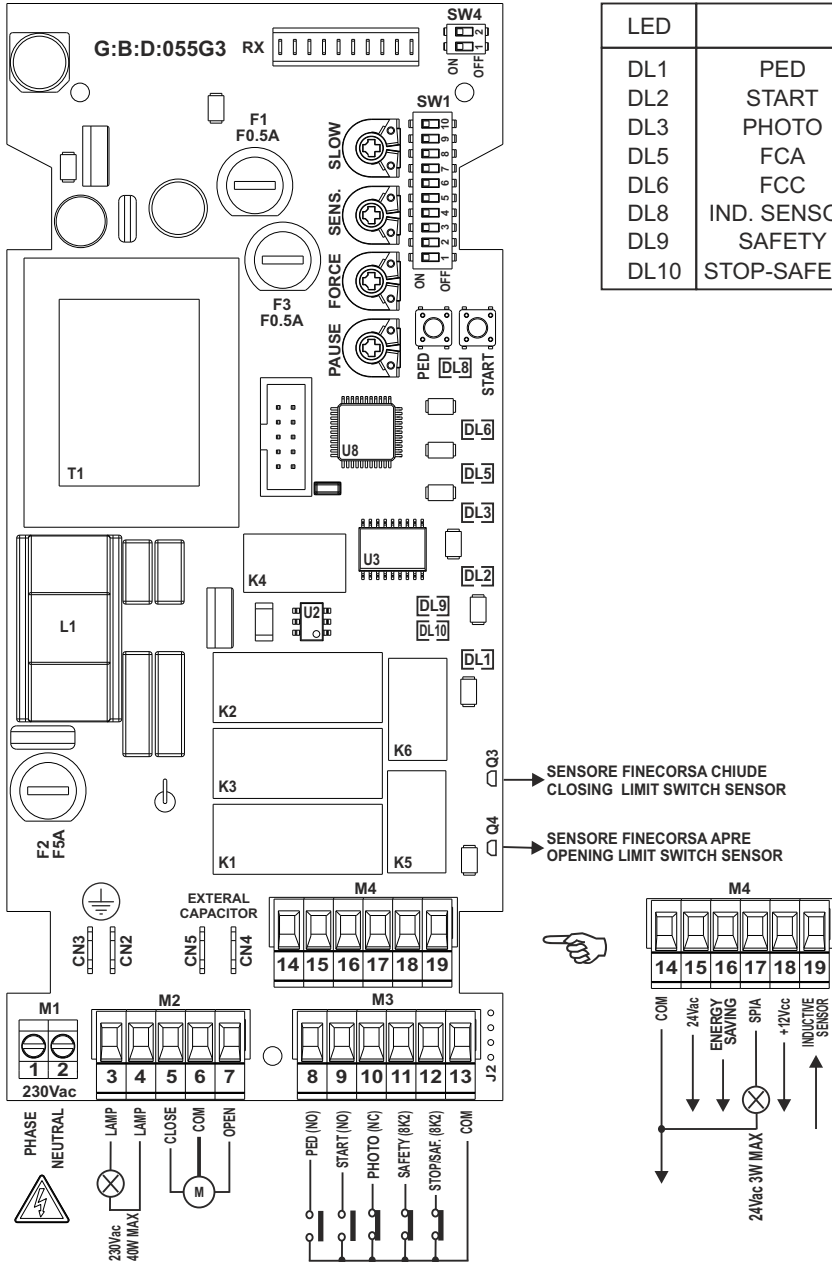

| LED | |
|------|-------------|
| DL1 | PED |
| DL2 | START |
| DL3 | PHOTO |
| DL5 | FCA |
| DL6 | FCC |
| DL8 | IND. SENSOR |
| DL9 | SAFETY |
| DL10 | STOP-SAFETY |

COLLEGAMENTO ALIMENTAZIONE / POWER SUPPLY CONNECTION

2

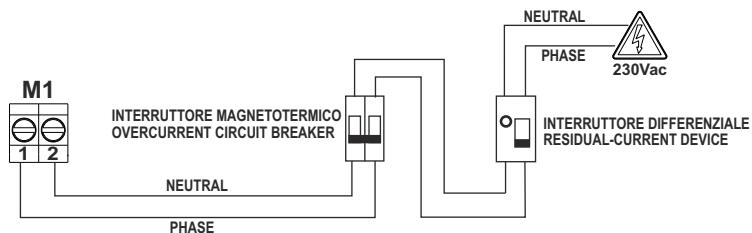

COLLEGAMENTO DI TERRA / EARTH CONNECTION

3

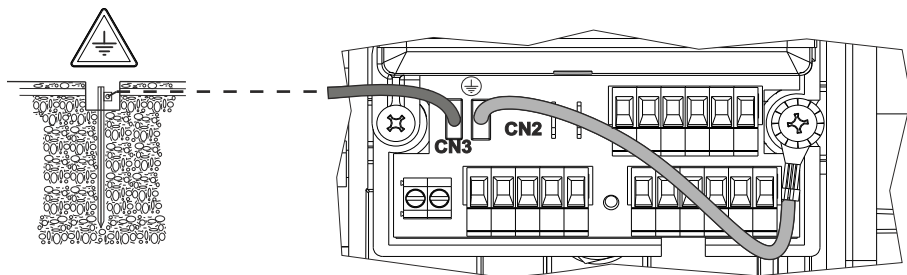

COLLEGAMENTO MOTORE / MOTOR CONNECTION

4

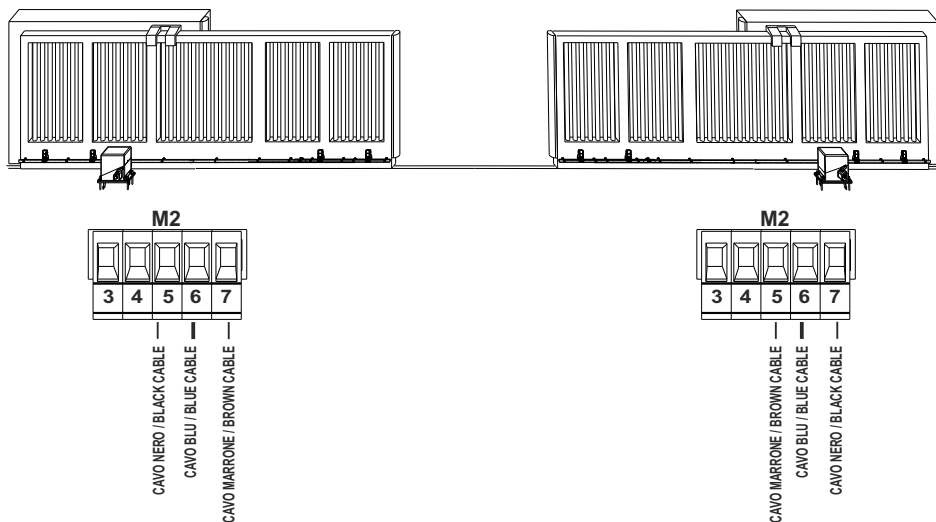

I-UK

INSTALLAZIONE SENZA RALLENTAMENTI / INSTALLATION WITHOUT DECELERATIONS

6

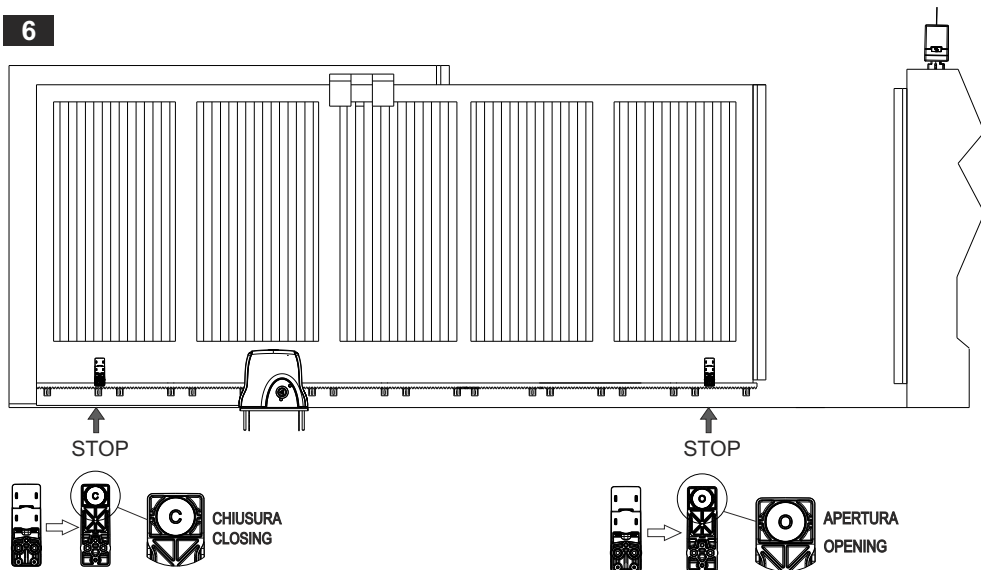

INSTALLAZIONE CON RALLENTAMENTI / INSTALLATION WITH DECELERATIONS

7

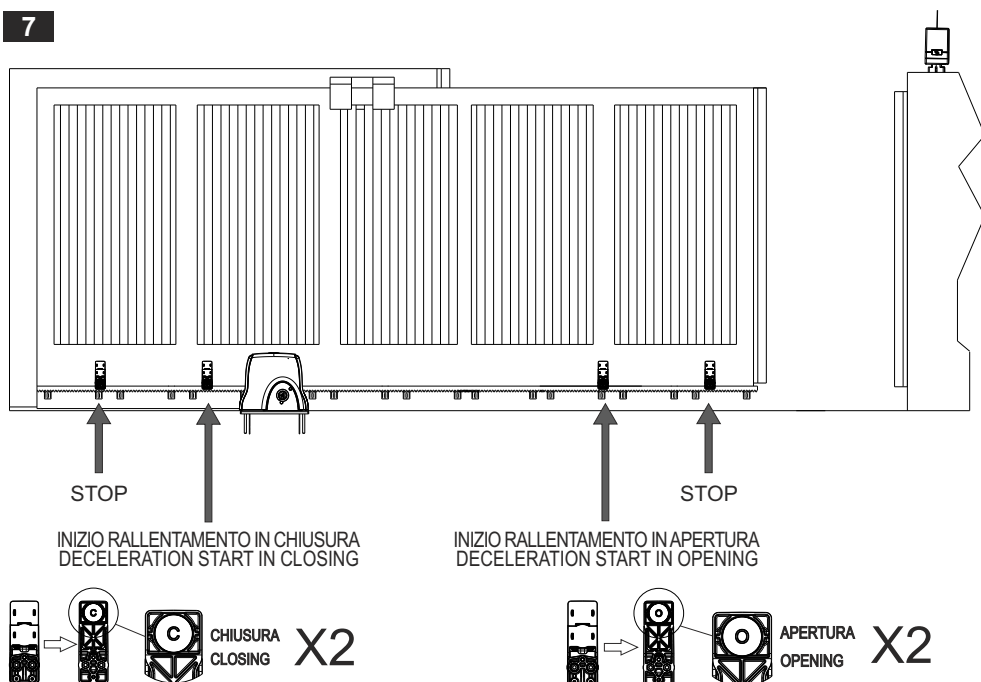

COLLEGAMENTO CONDENSATORE / CAPACITOR CONNECTION

8

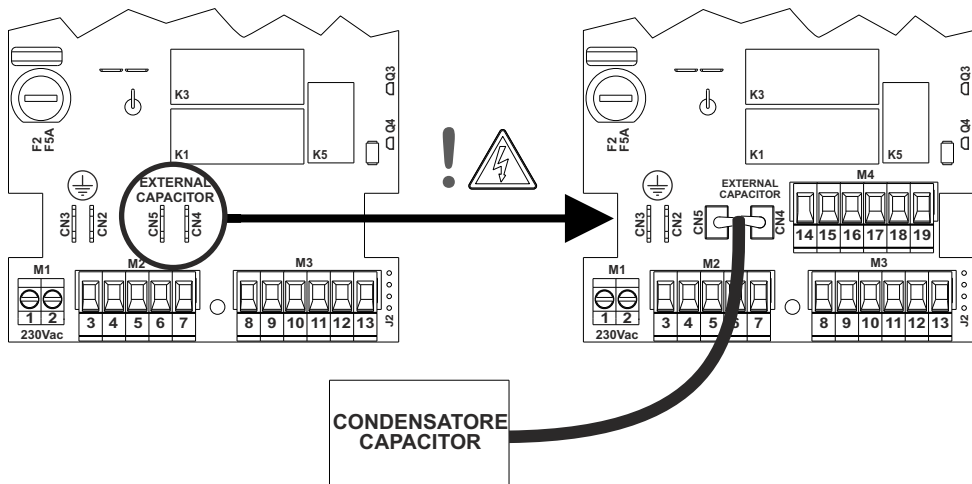

COLLEGAMENTO LAMPEGGIANTE / FLASHING LIGHT CONNECTION

9

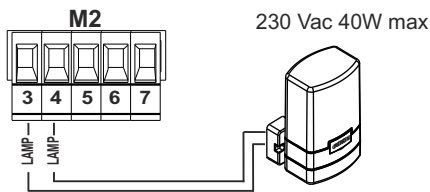

| | | DIP SWITCH 3 | |
|------|-------|--------------|--|
| Ref | | | |
| ON: | on 3s | on 3s | |
| OFF: | off | off | |
| ON: | on | on | |
| OFF: | off | off | |

COLLEGAMENTO DISPOSITIVI DI COMANDO / CONTROL DEVICES CONNECTION

10

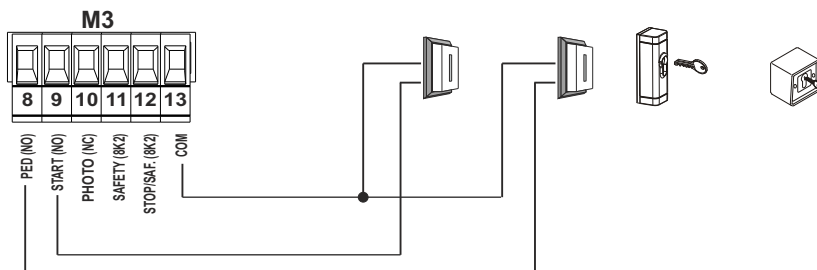

I-UK

COLLEGAMENTO FOTOCELLULE / PHOTOCELLS CONNECTION

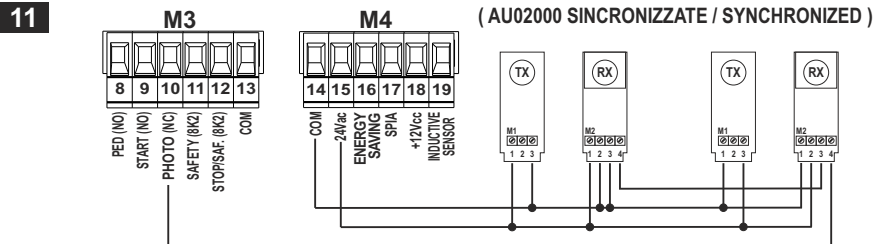

COLLEGAMENTO FOTOCELLULE CON TEST / PHOTOCELLS CONNECTION WITH TEST

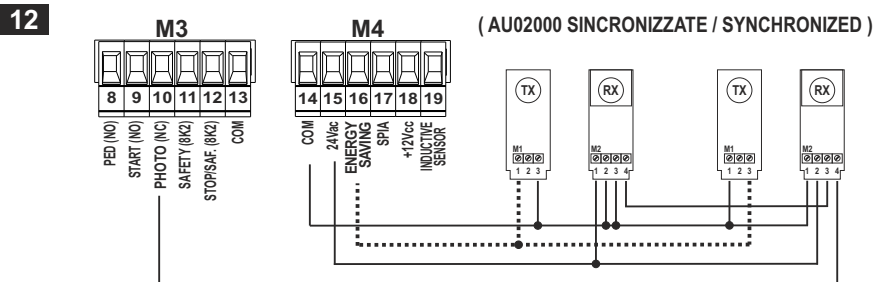

COLLEGAMENTO FOTOCELLULE / PHOTOCELLS CONNECTION

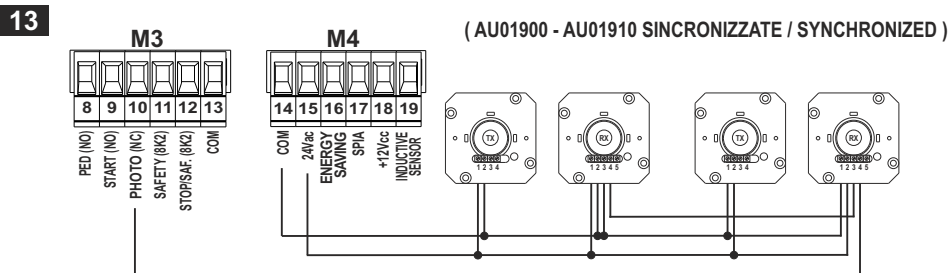

COLLEGAMENTO FOTOCELLULE CON TEST / PHOTOCELLS CONNECTION WITH TEST

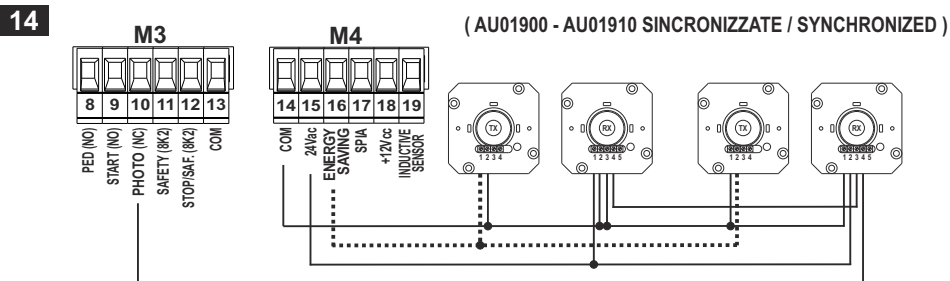

COLLEGAMENTO "DISPOSITIVO DI SICUREZZA" NC / NC "SAFETY DEVICE" CONNECTION

15

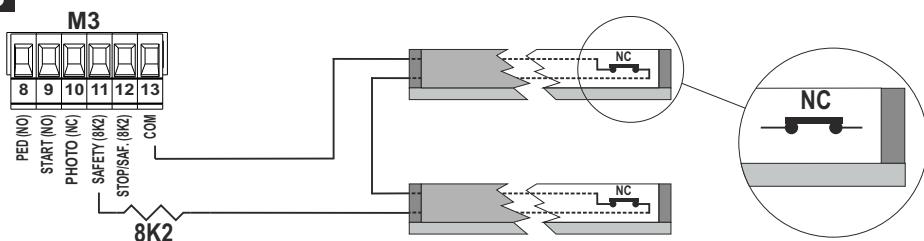

COLLEGAMENTO "DISPOSITIVO DI SICUREZZA" 8K2 / 8K2 "SAFETY DEVICE" CONNECTION

16

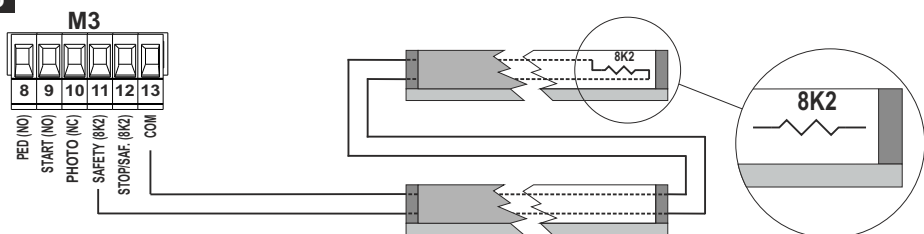

COLLEGAMENTO "DISPOSITIVO DI SICUREZZA" NC AGGIUNTIVO / ADDITIONAL NC "SAFETY DEVICE" CONNECTION

17

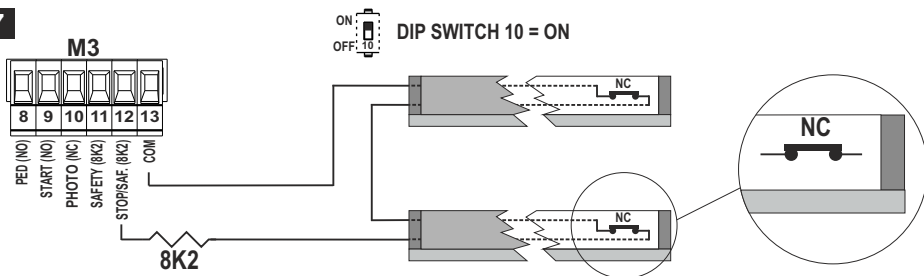

COLLEGAMENTO "DISPOSITIVO DI SICUREZZA" 8K2 AGGIUNTIVO / ADDITIONAL 8K2 "SAFETY DEVICE" CONNECTION

18

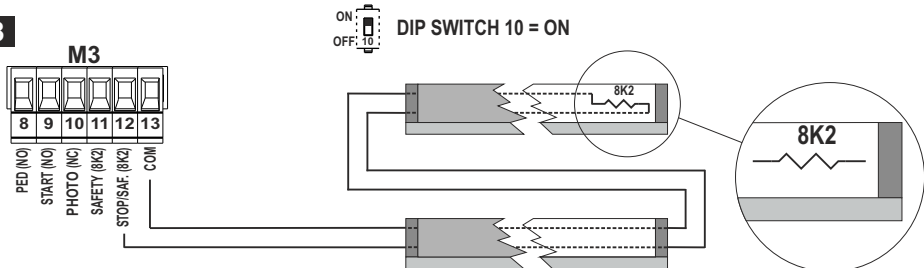

I-UK

COLLEGAMENTO STOP / STOP CONNECTION

19

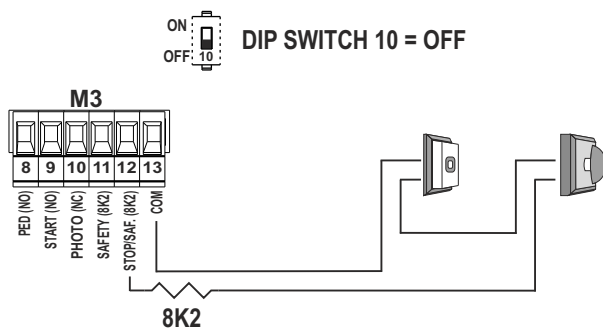

COLLEGAMENTO SPIA DI SEGNALAZIONE / WARNING LIGHT CONNECTION

20



COLLEGAMENTO SENSORE GIRI MOTORE / MOTOR RPM SENSOR

21

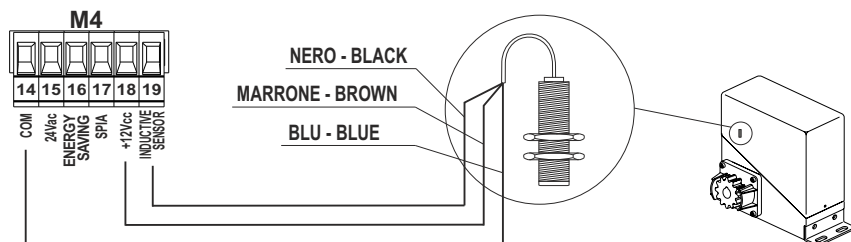

IMPOSTAZIONE DI DEFAULT DIP SWITCH SW1 / DIP SWITCH SW1 DEFAULT SETTINGS

22

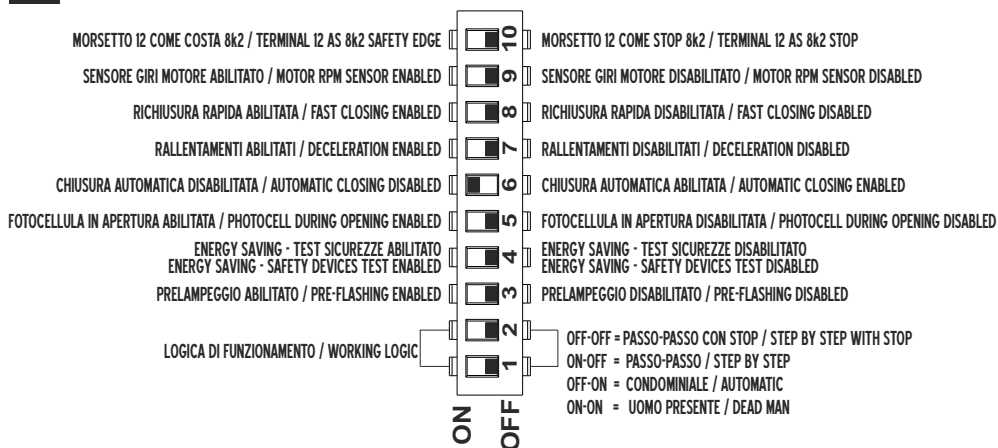

IMPOSTAZIONE DI DEFAULT DIP SWITCH SW4 / DIP SWITCH SW4 DEFAULT SETTINGS

23



LEGGERE IL MANUALE PRIMA DI MODIFICARE LE IMPOSTAZIONI DI DEFAULT
READ THE MANUAL BEFORE MODIFYING DEFAULT SETTINGS

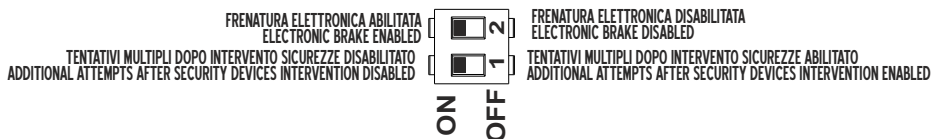

TRIMMER "PAUSE"

24



PAUSA 2 SECONDI
PAUSE 2 SECONDS



TEMPO PAUSA 220 SECONDI
PAUSE 220 SECONDS

I-UK

TRIMMER "FORCE"

25

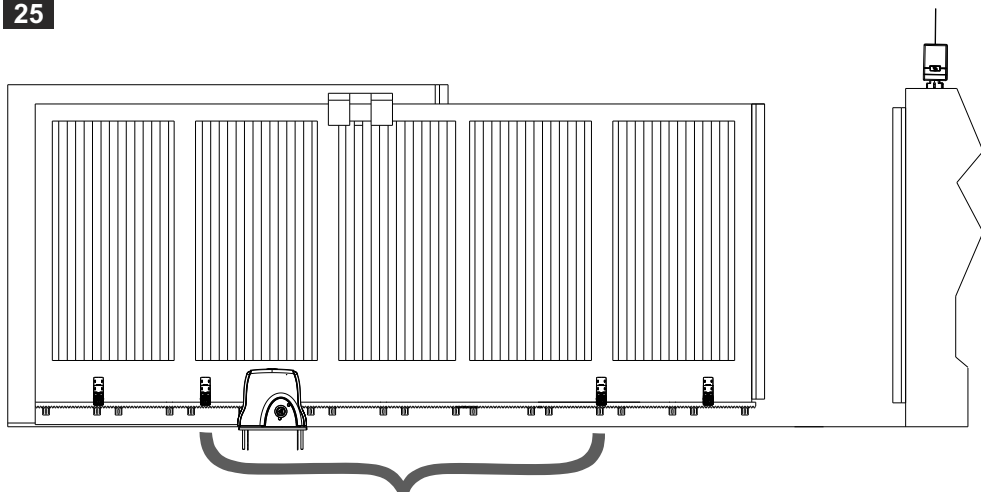

MOVEMENT SPEED : 50% - THRUST FORCE: 25%
 VELOCITA' ANTA : 50% - FORZA DI SPINTA : 25%



MOVEMENT SPEED : 100% - THRUST FORCE: 25%
 VELOCITA' ANTA : 100% - FORZA DI SPINTA : 25%



MOVEMENT SPEED : 100% - THRUST FORCE: 50%
 VELOCITA' ANTA : 100% - FORZA DI SPINTA : 50%



MOVEMENT SPEED : 100% - THRUST FORCE: 100%
 VELOCITA' ANTA : 100% - FORZA DI SPINTA : 100%

TRIMMER "SENS"

26

SENSIBILITA' INTERVENTO SENSORE ANTISCHIACCIAMENTO
 INTERVENTION SENSITIVITY OF ANTICRUSHING SENSOR



ALTA SENSIBILITA'
 HIGH SENSITIVITY



MEDIA SENSIBILITA'
 MEDIUM SENSITIVITY



BASSA SENSIBILITA'
 LOW SENSITIVITY

TRIMMER "SLOW"

27

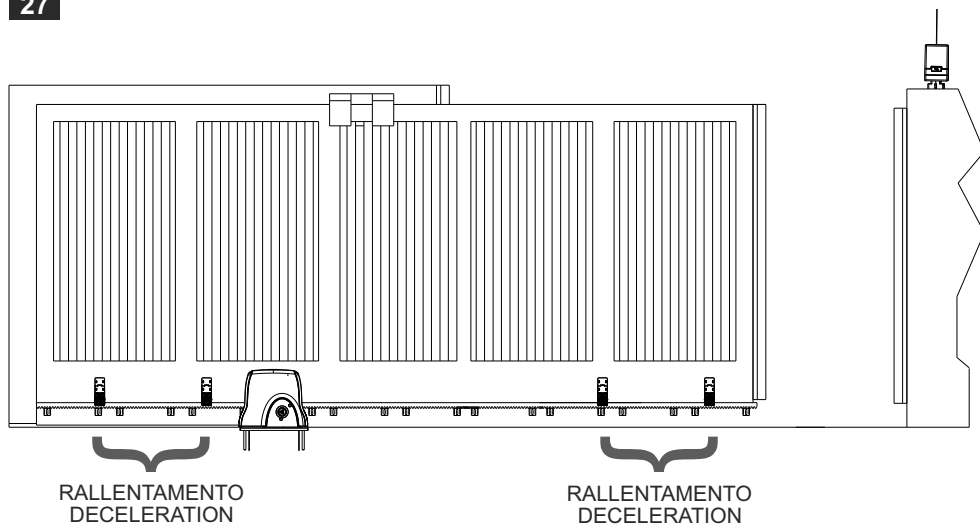

MOVEMENT SPEED : 50% - THRUST FORCE: 25%
 VELOCITA' ANTA : 50% - FORZA DI SPINTA : 25%



MOVEMENT SPEED : 100% - THRUST FORCE: 25%
 VELOCITA' ANTA : 100% - FORZA DI SPINTA : 25%



MOVEMENT SPEED : 100% - THRUST FORCE: 50%
 VELOCITA' ANTA : 100% - FORZA DI SPINTA : 50%



MOVEMENT SPEED : 100% - THRUST FORCE: 100%
 VELOCITA' ANTA : 100% - FORZA DI SPINTA : 100%

GIBIDI

G.I.B.I.D.I. S.r.l.

Via Abetone Brennero, 177/B
46025 Poggio Rusco (MN) - ITALY
Tel. +39.0386.52.20.11
Fax +39.0386.52.20.31
E-mail: info@gibidi.com

Numero Verde: 800.290156

www.gibidi.com

