

G:B:D:

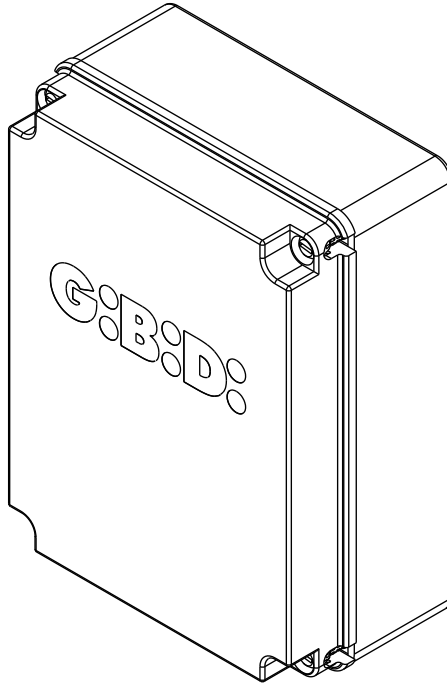

:BX-6M

CE

BX-6M- AS07010

Apparecchiatura elettronica
SCHEMA ELETTRICO E COLLEGAMENTI

Electronic control unit
ELECTRICAL CONNECTIONS

I UK

I-UK**I**

- Questo prodotto è stato collaudato da Gi.Bi.Di., verificando la perfetta corrispondenza delle sue caratteristiche alle direttive vigenti.
- Gi.Bi.Di. S.r.l. si riserva la facoltà di modificare i dati tecnici senza alcun preavviso, in funzione dell'evoluzione del prodotto.

**LEGGERE ATTENTAMENTE QUESTO MANUALE PRIMA DI PROCEDERE ALL'INSTALLAZIONE.****UK**

- This product has been tested by Gi.Bi.Di. verifying the perfect correspondence of its characteristics to the current directive.
- Gi.Bi.Di. S.r.l. reserves the right to modify the technical data, without prior notice, depending on the product development.

**PLEASE READ CAREFULLY THIS MANUAL BEFORE PROCEEDING WITH THE INSTALLATION.**

DIMENSIONI / DIMENSIONS

1

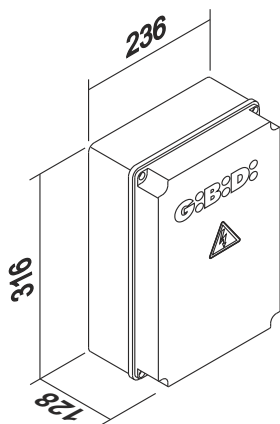

INSTALLAZIONE / INSTALLATION

2

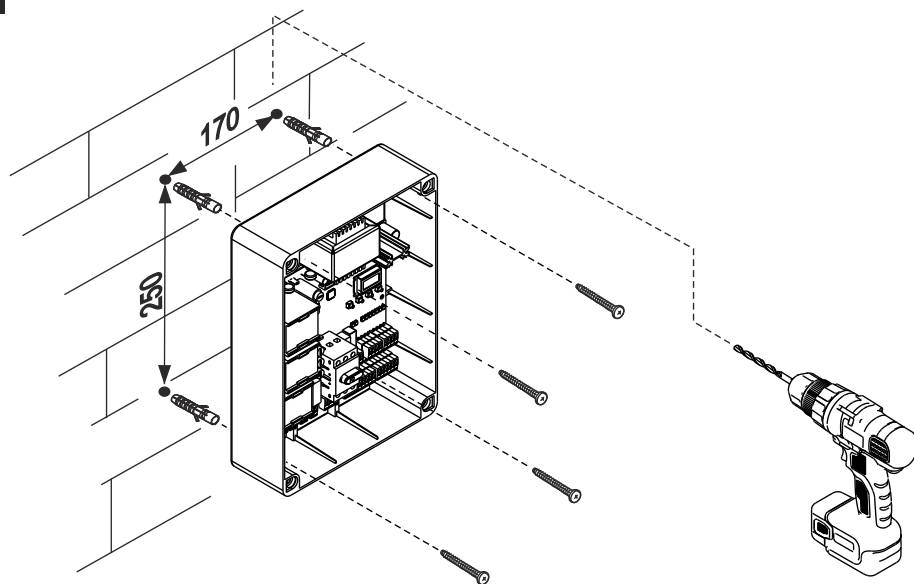

I-UK

SCHEMA ELETTRICO TRASFORMATORE / TRANSFORMER ELECTRICAL CONNECTIONS

3A

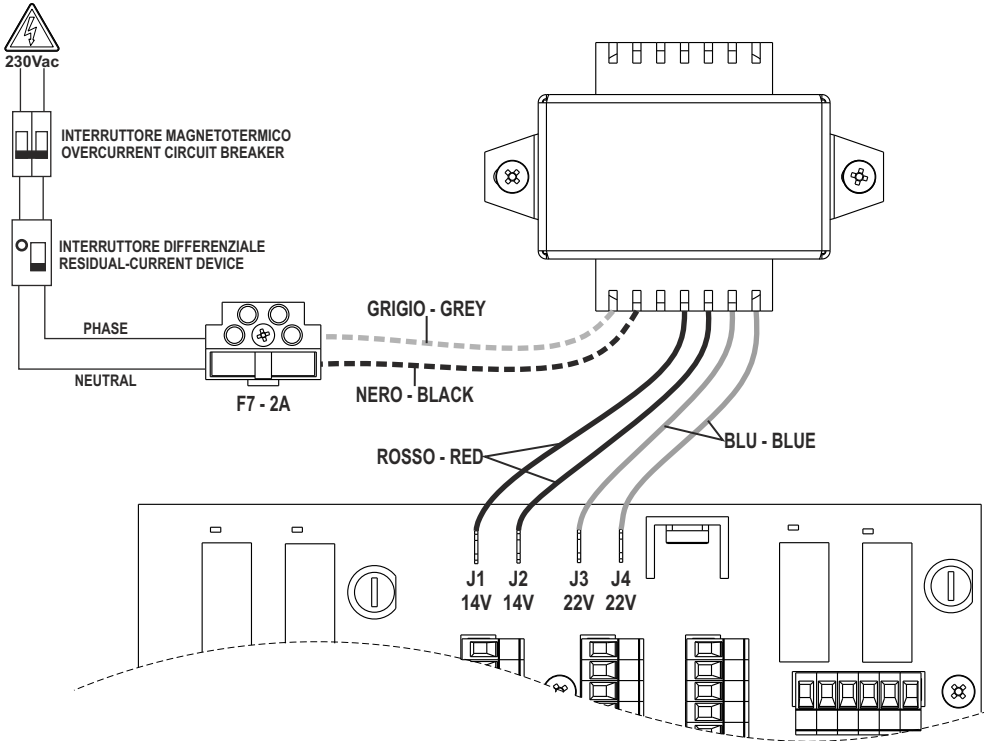

MORSETTO M3, ALIMENTAZIONE MOTORI / M3 TERMINAL BLOCK, MOTORS POWER

3B

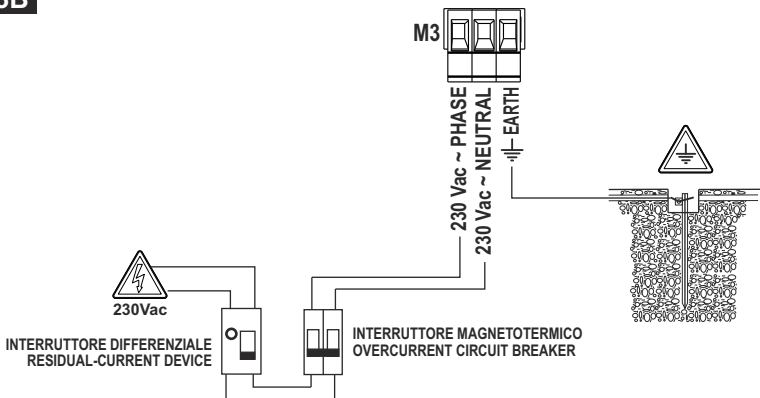

SCHEMA ELETTRICO / ELECTRICAL CONNECTIONS

4

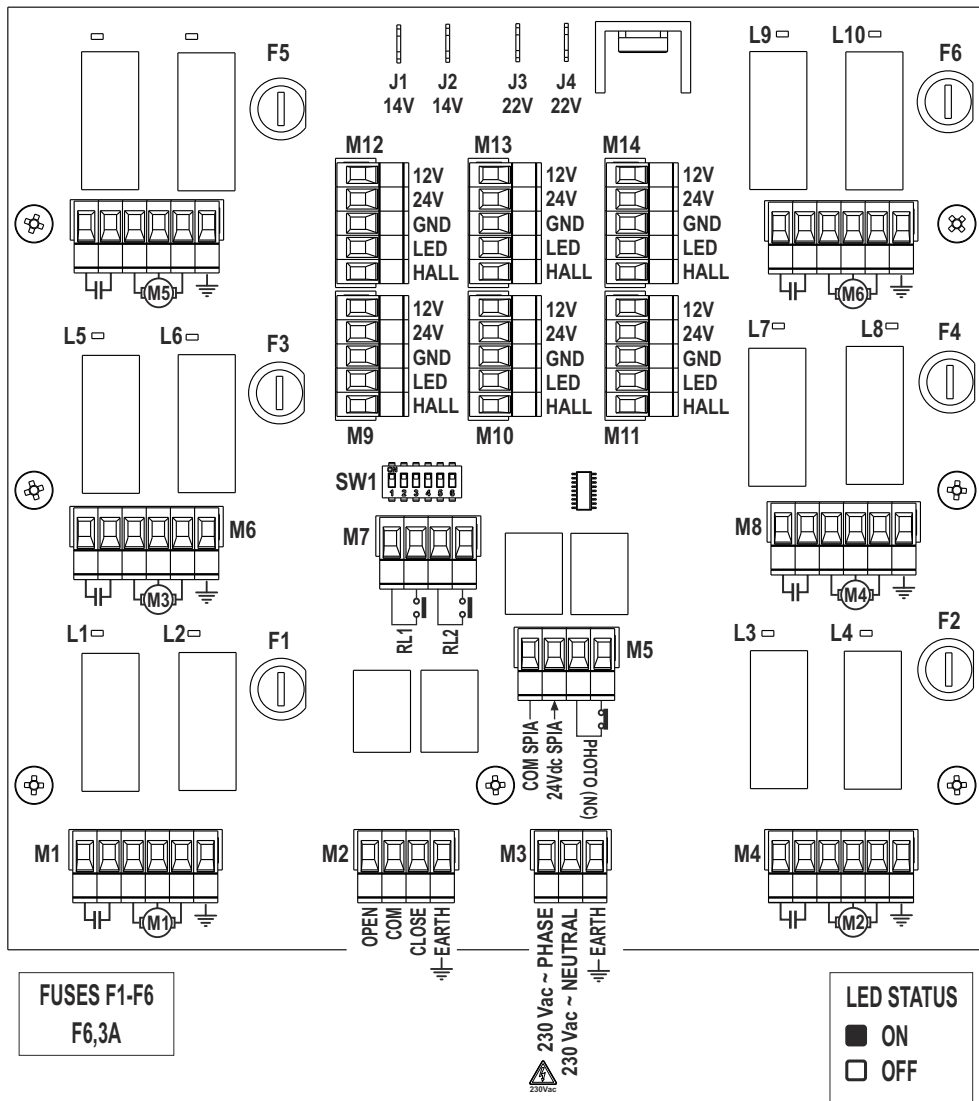

I-UK

CONNESSIONE MOTORI / MOTORS CONNECTIONS

5

DESCRIZIONE CAVI / CABLES DETAILS

1	Marrone / Brown	Apertura / Opening
2	Grigio / Grey	COM
3	Nero / Black	Chiusura / Closing
4	Giallo-verde / Yellow-green	Terra / Ground

M1-M4-M6-M8-M15-M16

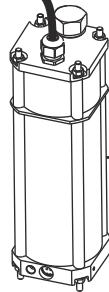
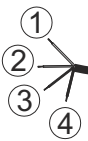
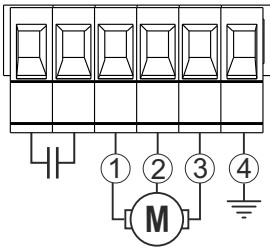

X6

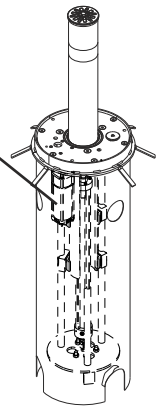
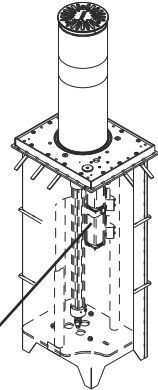

CONNESSIONE COPERCHI / BOLLARD CAPS CONNECTIONS

6

M9-M10-M11-M12-M13-M14

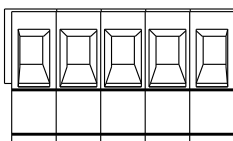

HALL
LED
GND
24V
12V

CAVO VERDE / GREEN CABLE 12V
CAVO MARRONE / BROWN CABLE 24V
CAVO GRIGIO / GREY CABLE GND
CAVO GIALLO / YELLOW CABLE LED
CAVO BIANCO / WHITE CABLE HALL

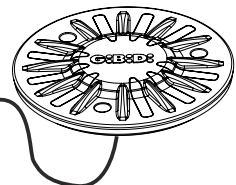

X6

MORSETTO M2 / TERMINAL BLOCK M2

7

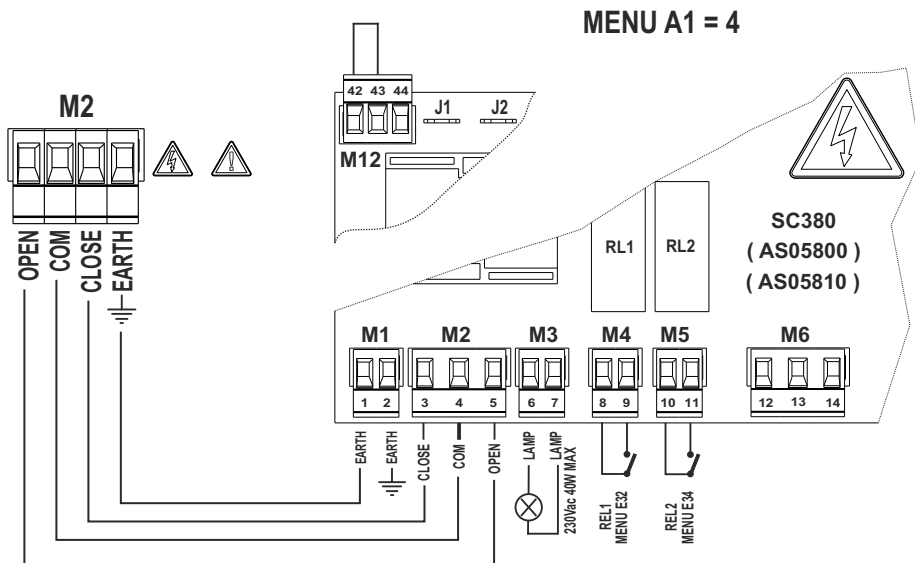

MORSETTO M7 / TERMINAL BLOCK M7

8

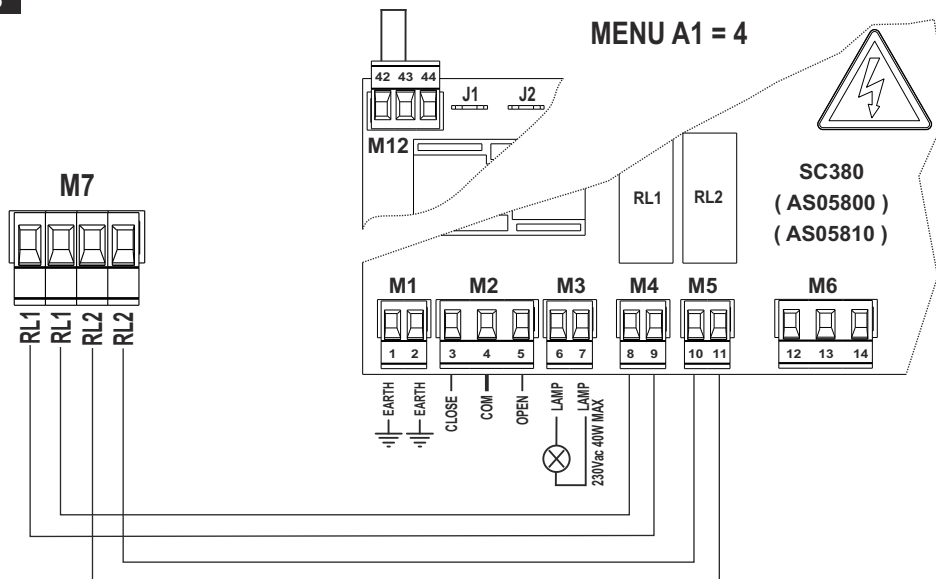

I-UK

MORSETTO M5 / TERMINAL BLOCK M5

9

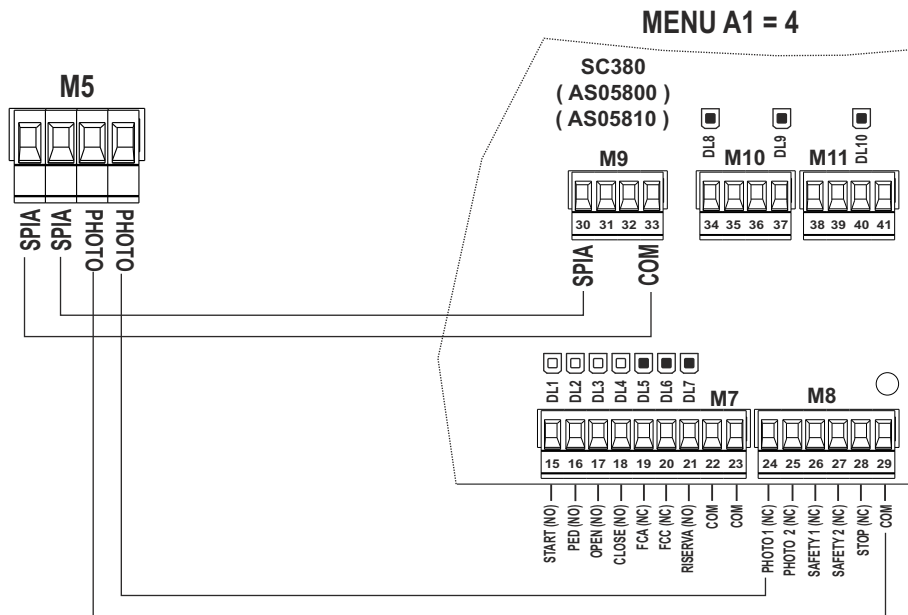

MORSETTO M7 E SWITCH SW1 / TERMINAL BLOCK M7 AND SWITCH SW1

10

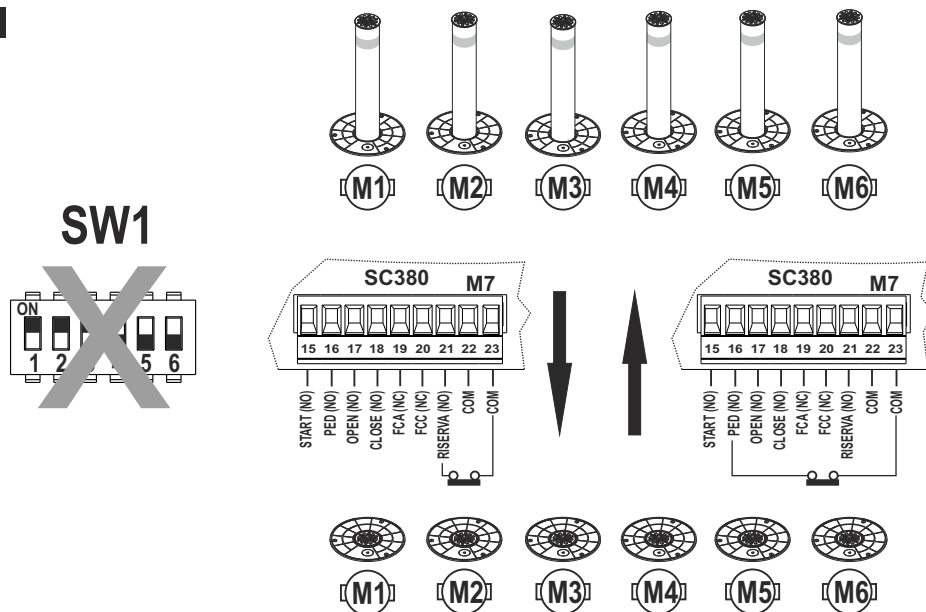

MORSETTO M7 E SWITCH SW1 / TERMINAL BLOCK M7 AND SWITCH SW1

11

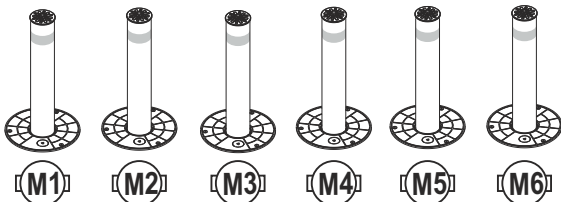

SW1

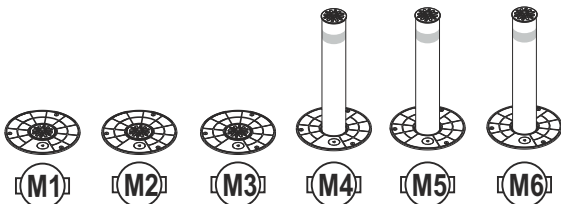
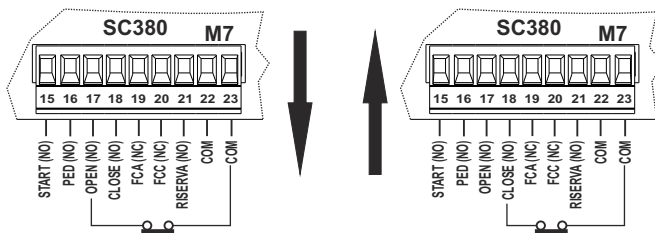
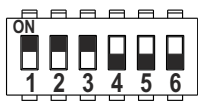

I-UK

Dichiarazione di conformità CE

Il fabbricante:

GI.BI.DI. S.r.l.

Via Abetone Brennero, 177/B,
46025 Poggio Rusco (MN) ITALY

Dichiara che i prodotti:

APPARECCHIATURA BX-6M

Sono conformi alle seguenti Direttive CEE:

- **Direttiva LVD 2006/95/CE e successive modifiche;**
- **Direttiva EMC 2004/108/CE e successive modifiche;**

e che sono state applicate le seguenti norme armonizzate:

- **EN60335-1,**
- **EN61000-6-2, EN61000-6-3**

Data 26/10/15

Il Rappresentante Legale
Michele Prandi



EC Declaration of Conformity

The manufacturer:

GI.BI.DI. S.r.l.

Via Abetone Brennero, 177/B,
46025 Poggio Rusco (MN) ITALY

declares that the product:

BX-6M ELECTRONIC CONTROL UNIT

is in conformity with the following EEC Directives:

- **LVD Directive 2006/95/EC and subsequent amendments;**
- **EMC Directive 2004/108/EC and subsequent amendments;**

and that the following harmonised standards have been applied:

- **EN60335-1,**
- **EN61000-6-2, EN61000-6-3**

Date 26/10/15

Legal Representative
Michele Prandi



GIBIDI

G.I.B.I.D.I. S.r.l.

Via Abetone Brennero, 177/B
46025 Poggio Rusco (MN) - ITALY
Tel. +39.0386.52.20.11
Fax +39.0386.52.20.31
E-mail: info@gibidi.com

Numero Verde: 800.290156

www.gibidi.com

