

G:B:D:



:CAPTIVE

CE UK
CA

CAP T868 / CAP T916
CAP ACTIVE
CAP R868 / CAP R916
CAP MAGIN

RadioBand3G System
USER MANUAL

EN

EN

1 - INTRODUCTION

1.1 - GENERAL DESCRIPTION

Radio safety solution for **industrial sliding gates** with NO-TOUCH technology.

Based on 3 devices:

- Transmitter (CAP T868/916, CAP ACTIVE 868),
- Receiver (CAP R868/916)
- Inhibition detector (CAP MAGIN).

• **Suitable for all kind of metallic / aluminum sliding gates**

• Category 2 devices.

! CAP system is not suitable for wooden gates neither other non conductive materials

The safety edge device provides security degree. NO-TOUCH detection is a courtesy function.

The NO-TOUCH detection is not working all of the time, it only works when the gate is in motion. **It detects metal or conductive objects near the safety edge.** It cannot detect plastics, glass or other non-conductive materials.

The receiver manages the activation and deactivation of NO-TOUCH function depending on the status of the inhibition detector (inhibition input).

Inhibition detector is based on magnetic fields thanks to the use of 2 polarized magnets (grey and black). **These 2 magnets are responsible for activating and deactivating NO-TOUCH sensor on the transmitter.** It is necessary to deactivate NO-TOUCH sensor at a distance of 30-50cm before the door is totally closed (inhibition zone).

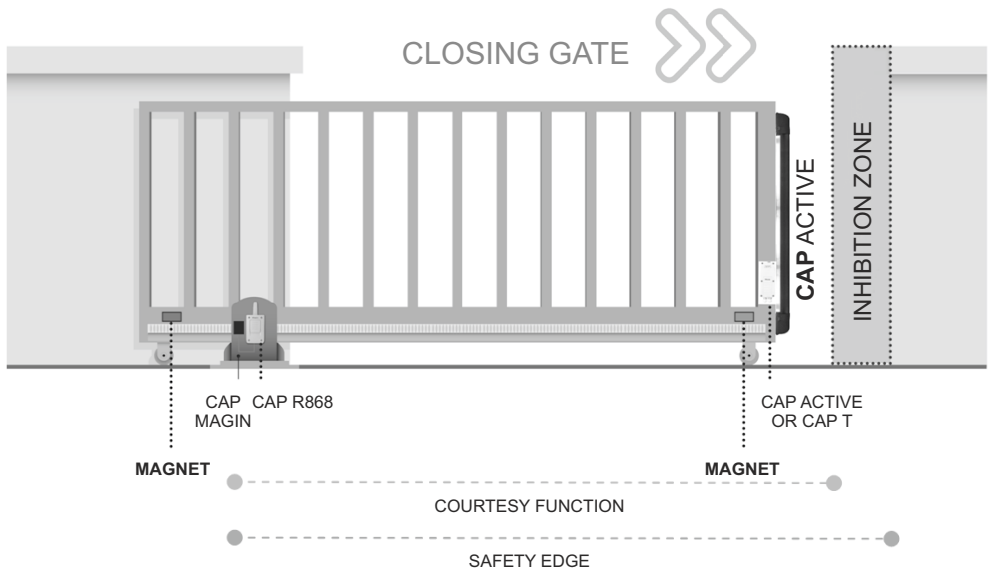

The system complies with EN ISO 13849-1:2008, category 2, PLd. (when the auto-test function is used).

1.2 - CAP T868/916 TRANSMITTER

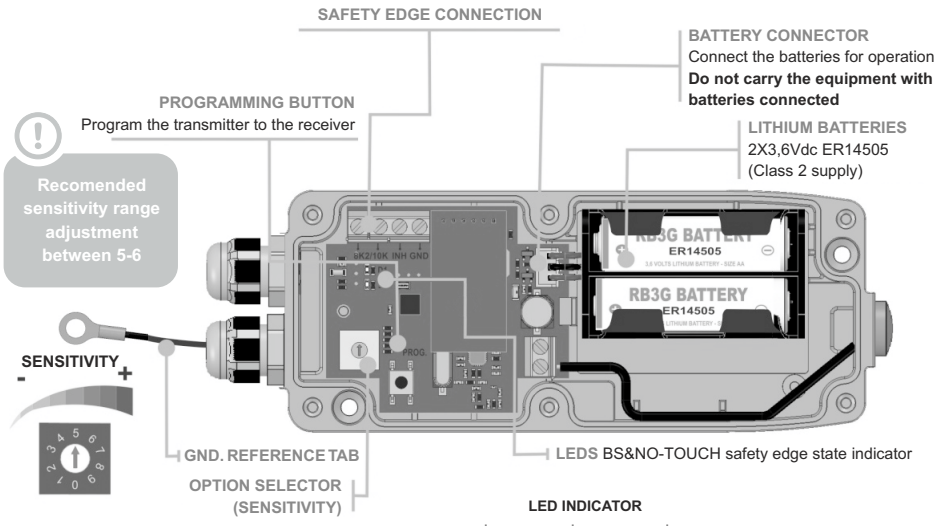

LED INDICATOR

LED	ON	FLASHING	OFF
D1	SAFETY EDGE		Normal use
D2	NO-TOUCH	Deactivated	

1.3 - CAP ACTIVE TRANSMITTER

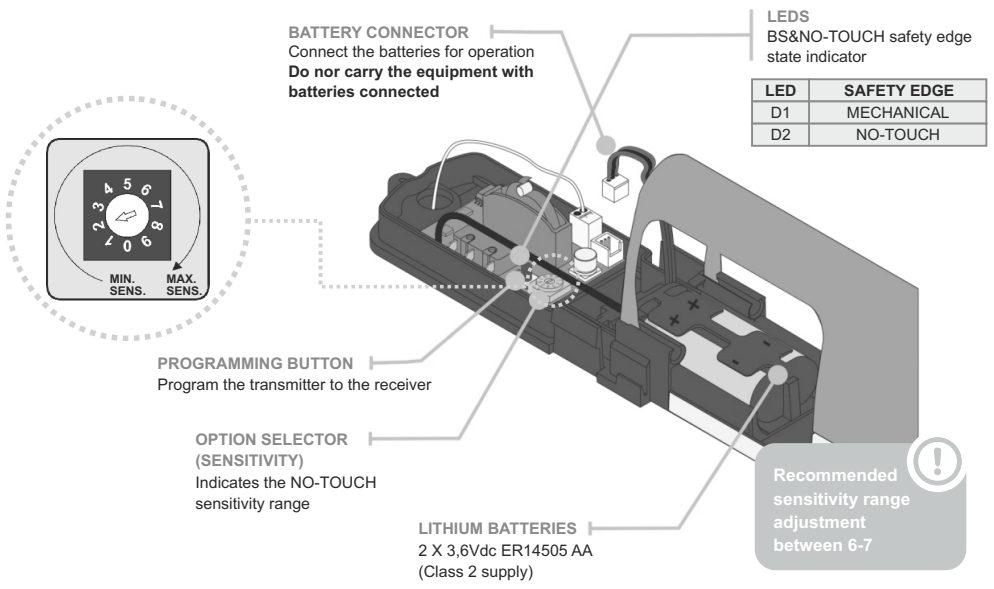

LED	SAFETY EDGE
D1	MECHANICAL
D2	NO-TOUCH

EN

1.4 - CAP R868/916 RECEIVER

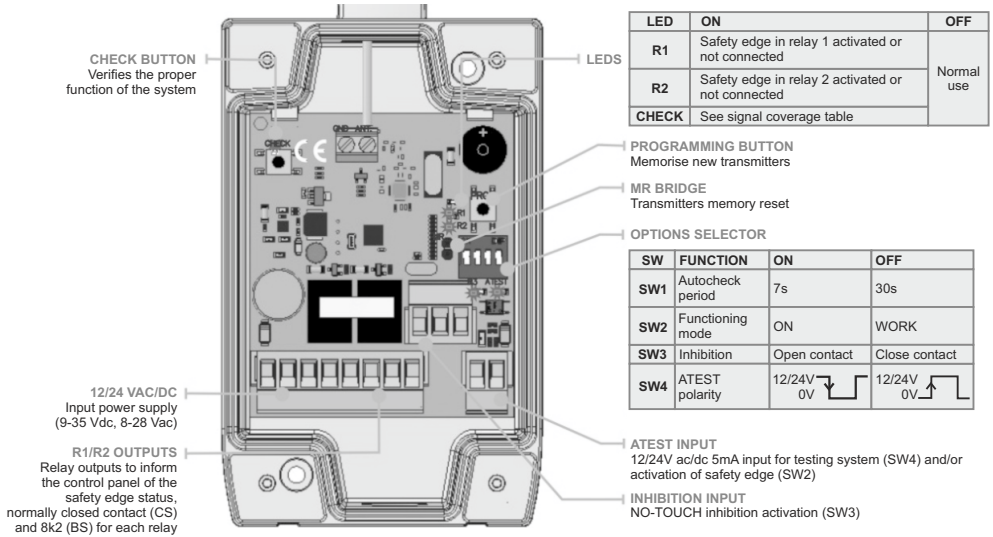

1.5 - CAP MAGIN

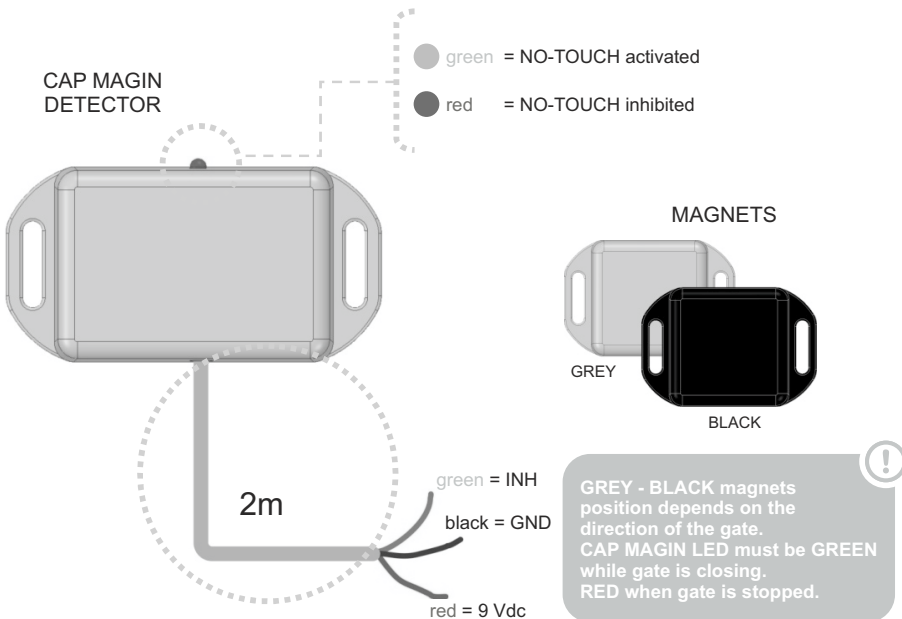

2 - DETECTION PRINCIPLES

CAP T detects objects near the safety edge of the gate by detecting variations between conductive part of the gate and conductive parts of the safety edge.

For this reason CAP T has a cable to connect GND to the metal part of the gate.

It is very important for the correct function of the NO TOUCH detection that the ground reference tab is properly connected to the gate.

The amount of detection/sensitivity is going to depend on:

- Size of the conductive part of the object.
- Distance from the object to the edge of the gate.

Maximum safety edge length = 2.5 m.

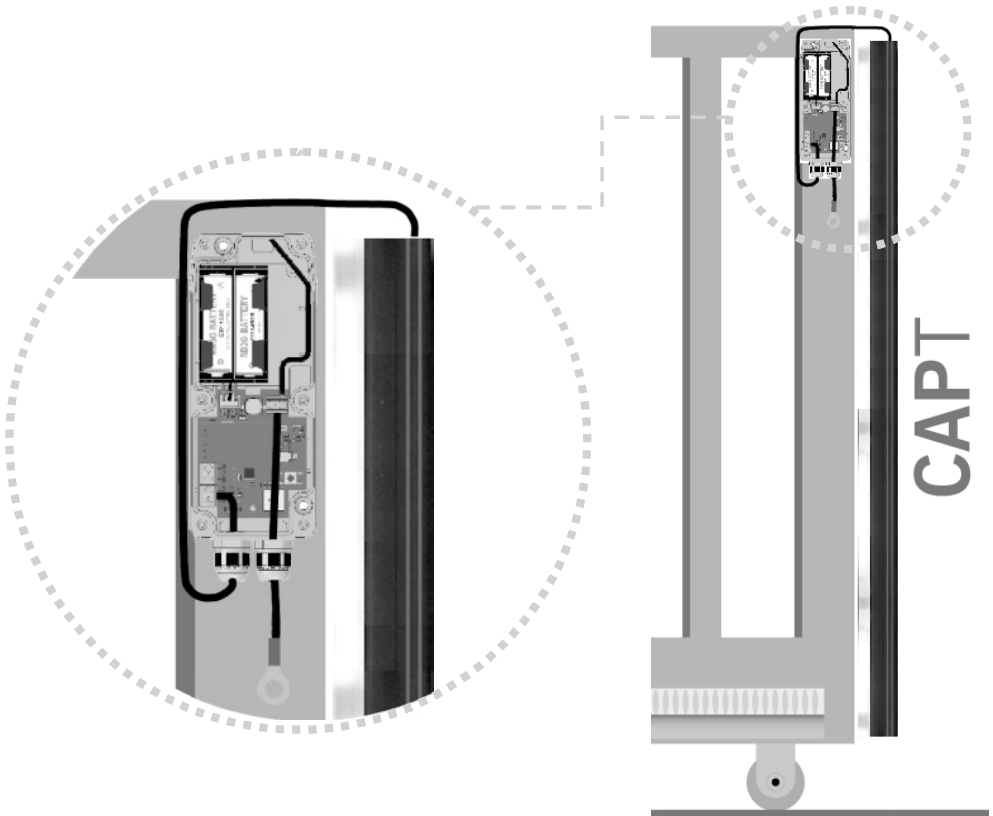

EN

3 - INSTALLATION

3.1 - CAP T/CAP R



RECEIVER



TRANSMITTER

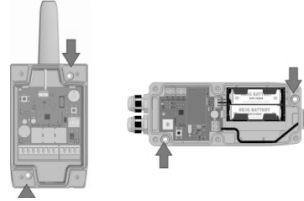

IMPORTANT

Do not place metal surfaces between transmitter and receiver.

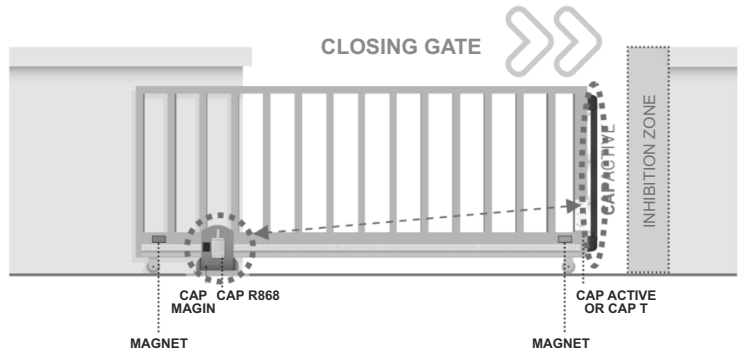

AVOIDING EXCESSIVE VIBRATION IS A MUST.

Use safety edges where **conductor cannot be moved easily** by the movement of the gate.

Use **metallic profiles** appropriated for the safety edge used.

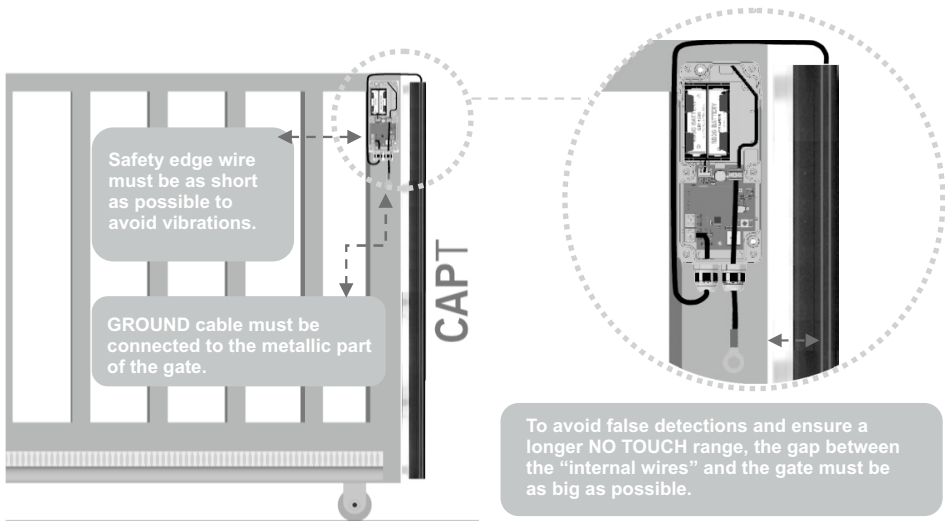

3.2 - CAP ACTIVE

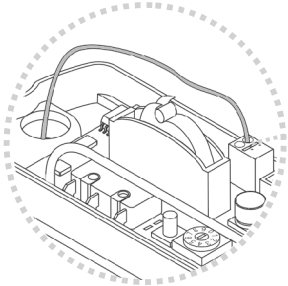

⚠ Ground cable must be fixed to the gate. Make sure that ground and antenna wires are NOT in contact.

Fix the clip to the column or to the gate as set out in (h/4 h/2 / h-h/4)

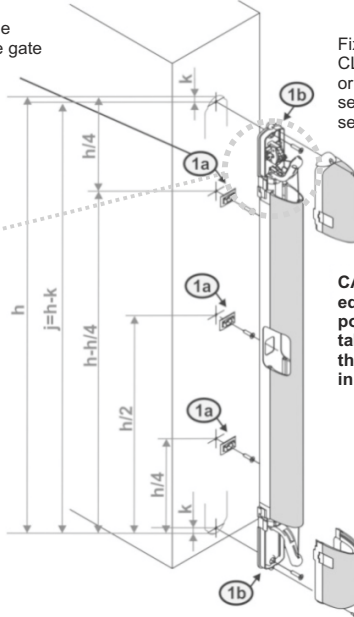

Fix the edge to the CLIP in the column or to the gate, and secure with screws, see (k/j).

CAP ACTIVE safety edge must be positioned vertically, taking care to mount the card with the board in the upper part.

Remove the locking pin (1c)

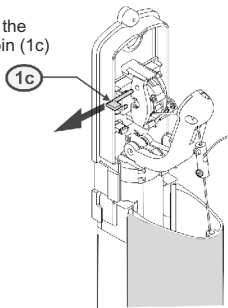

NOTE: in order to improve the discharge of any sediment that may be found inside the bottom cap, it is advisable to drill a hole, as shown in (1d)

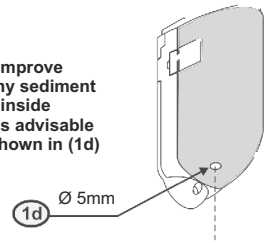

3.2.1 CABLE TENSIONING AND CALIBRATION

The safety edge is already provided with pretensioned cable. However, you can make further adjustment by turning the SCREW on the arm of the upper support of the edge.

- Turning clockwise will increase the sensitivity of the edge (+)
- Turning counterclockwise will decrease the sensitivity of the edge (-)

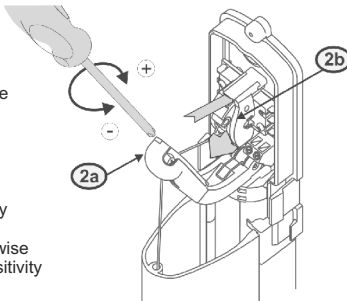

Optimum operation of the device is achieved, with the electrical intervention, with a deformation at the centre of the safety edge equal to about 20 mm.

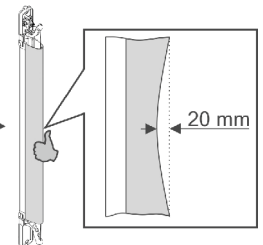

EN

3.2.2 POSITIONING OF THE COVER

To insert the soft cap, place it in front of the support plate, taking care to slide the flaps in their seats (3a) and the two lateral locking hooks inside of slits arranged (3b).

Apply a light pressure so that there is a click to indicate the correct placement of the same

Secure the cover with the screw provided.

To remove the cover reverse the procedure: remove the screw (3c), release the cap by inserting a tool inside the slits pushing the hooks inward.

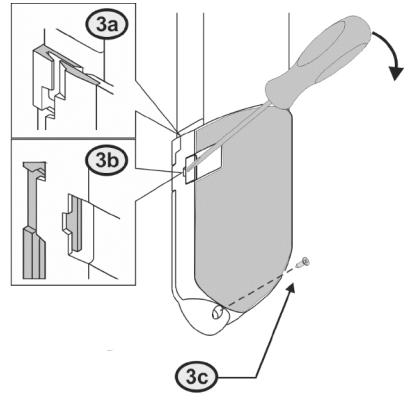

3.2.3 POWER SUPPLY

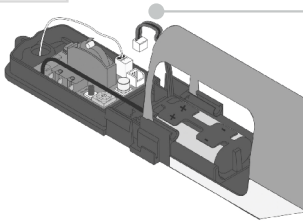

BATTERY CONNECTOR
Connect the batteries for operation.
Do not carry the equipment with batteries connected.

3.3 - CAP MAGIN



MAGNETS: at the gate.

The Grey magnet should be installed to activate the NO-TOUCH sensor when the gate starts the closing movement. The Black magnet switches off the NO-TOUCH sensor in order to allow the gate to close fully.

Depending on the gate direction, **BLACK** magnet is the one which de-activates the NO-TOUCH. 

GREY – BLACK magnets position depends on the direction of the gate. CAP MAGIN LED must be GREEN while gate is closing/opening, RED when gate is totally closed/open.



CAP MAGIN: install onto a support near the magnets and at the same height

In case the gate is not totally opened/closed, a safety time of 5 minutes is added to avoid battery consumption. Maximum NO TOUCH activation time = 5 minutes 

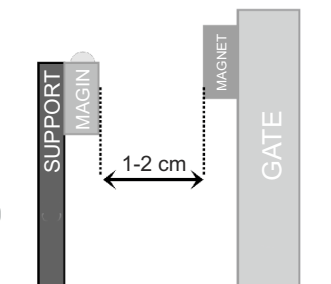

3.3.1 FIXING THE ACTIVATION MAGNET



With the **GATE TOTALLY OPEN** fix the south field magnet (Grey).

The Grey magnet must be 2-3 cm away from the MAGIN detector. When the gate starts closing, the Grey magnet travels past the MAGIN and NO-TOUCH gate sensor is activated.

LED indicator on MAGIN detector changes to green color when Grey magnet passes in front of MAGIN.

Before fixing the magnet, **CAP ACTIVE/CAP T** must be programmed at the receiver.

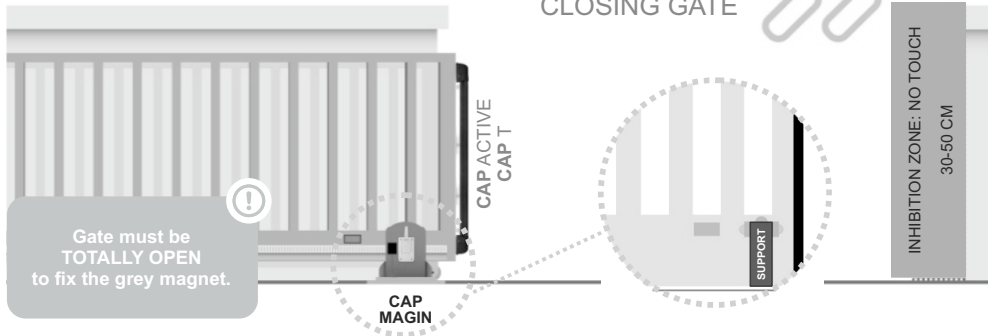

3.3.2 FIXING THE DEACTIVATION MAGNET



Before fixing the black magnet, **CAP ACTIVE/CAP T** must be programmed at the receiver.

With the **GATE AT 30-50 cm FROM ITS CLOSED POSITION**:

The Black magnet must be fixed at the other extreme of the gate (in respect of the grey magnet). The location of this magnet depends on the inhibition zone desired.

Due to NO TOUCH detection, it is required that an **INHIBITION ZONE** is created at the end of the gate movement in order to avoid the detection of the wall support by NO TOUCH detector. In this zone, the safety edge will only be activated from normal mechanical compression.

Inhibition zone length depends on NO TOUCH sensitivity adjustment.

When NO-TOUCH sensor is detecting, an LED on the transmitter is activated. If the indicators on the transmitter are switched off, it will be necessary to press the PROG button on the transmitter to activate, for 5 minutes, the LED function.

The LED indicator on MAGIN detector changes to a red color when black magnet passes in front of the MAGIN.

The location of the black magnet indicates the inhibition zone at closing.



EN

4 - CONNECTIONS

4.1 - CONNECTING THE CAP T (safety edge)



Supports 8k2/10k resistive safety edges.

INHibition input (N.O.) on the transmitter works in the same way as inhibition input on the receiver.

A closing signal in INH switches off the NO-TOUCH sensor.

Ground cable must be fixed to the gate. Make sure that ground and antenna wires are NOT in contact.

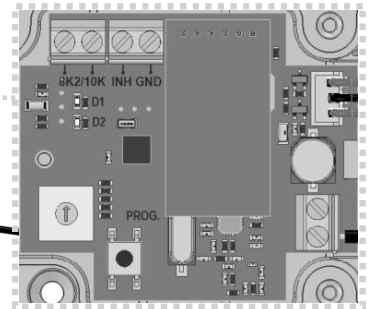

4.2 - CONNECTING THE CAP ACTIVE (safety edge)

Check the ground wire is properly fixed and the cable tension is calibrated.

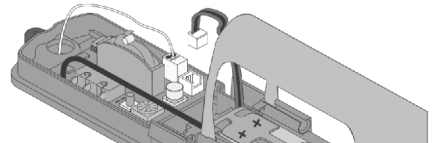

4.3 - CONNECTING THE RECEIVER TO THE CONTROL PANEL

Connecting the safety outputs to gate control panel:

The equipment can be connected to the gate control panel to any input for safety edge 8k2 or directly into a safety input normally closed contact as if it were a photocell or stop signal.

This connectivity exists for R1 and R2 outputs.

EXAMPLE: connection to gate control panel with safety contact / STOP input

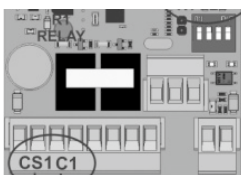

CONTROL PANEL

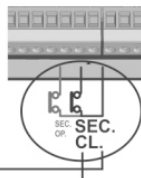

Safety edge status	R1 status	R1 LED
Safety edge OK	Close	OFF
Safety edge activated or not programmed	Open	ON

EXAMPLE: connection to gate control panel with input for safety edge 8k2

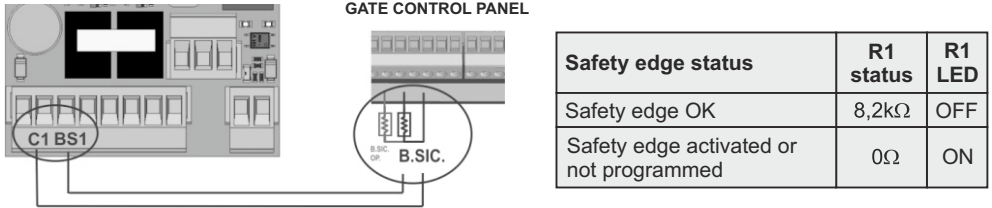

In order to comply with EN ISO 13849-1: 2008 safety standard, a signal to test the system must be connected.

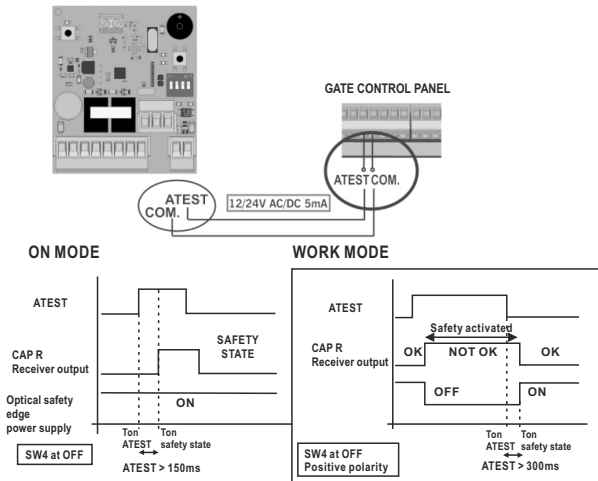

When working with optical safety edges, in ON mode, only OSE-S7502 are allowed as they remain always active. The radio communication is tested every 7 or 30 seconds depending on the selector SW1 of the receiver.

In WORK mode, the ATEST signal is used to power up and down the optical safety edges. The radio communication is tested as in ON mode and when the optical elements are powered up and down.

4.4 - CONNECTING MAGIN TO THE RECEIVER

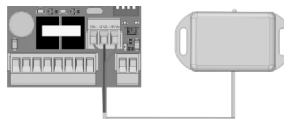





Any kind of external signal is suitable to manage the activation / deactivation of the NO TOUCH function. A dry contact signal must be connected into INH – GND terminal. Selector 3 on the receiver selects the inhibition signal polarity (NO or NC) to be able to apply different kind of signals.

When INH LED on the receiver is switched on, the NO TOUCH sensor is deactivated.

EN

5 - ADJUSTMENT OF THE RECIVER / OPERATING MODES

AUTOCHECK PERIOD				
SW1		↑	7 s	The system performs a complete test of the equipment, including radio communication.
		↓	30 s	
OPERATING MODE WITH OPTICAL SAFETY EDGES				
SW2		↑	ON	In ON mode, only "always on" optical safety edges (OSE-S7502) are permitted, as the optical element always is on.
		↓	WORK	In WORK mode, the optical elements are OFF meanwhile the ATEST signal is active. So it is necessary to disconnect this ATEST signal during the gate movement.
INHIBITION POLARITY				
SW3		↑	Open contact	Open contact in "INH-GND" connector switches off NO TOUCH detector.
		↓	Close contact	Close contact in "INH-GND" connector switches off NO TOUCH detector (CAP MARGIN)
ATEST SIGNAL POLARITY (depends on the control panel)				
SW4		↑	Negative	ATEST negative: ATEST signal is a fixed 12 or 24V signal that the control panel sets to 0V to make the system check.
		↓	Positive	ATEST positive: ATEST signal is disconnected and when the control panel makes a test it provides a 12 or 24V signal.

In the case of operating without ATEST signal, it is necessary to work with ATEST set to positive. In order to comply with the EN ISO 13849-1: 2008 safety standard, you must connect this signal to test the system.

ON/WORK mode

The operating mode is selected by the SW2 of the receiver. This selector is necessary when working with optical safety edges. All transmitters in the receiver work in the same way. **It will be necessary to reset the receiver when changing the operating mode with transmitters already memorised.**

With **standard optical safety edges**, WORK mode must be used due to high consumption of the optical elements.

With **OSE-S7502 "always on" optical safety edges**, both modes are allowed. In ON mode, the system becomes universal for any control panel. In WORK mode the battery life is maximized thanks to the shutdown of the optical elements.

6 - PROGRAMMING

6.1 - PROGRAMMING SAFETY EDGE TO RECEIVER

CAP R868/916 receiver can work with standard RB3 transmitters and new CAP ACTIVE/CAP T transmitter (NO-TOUCH function) at the same time.

Inhibition input (switch on and off the NO-TOUCH function) will affect all CAP ACTIVE/CAP T transmitters in the same way. It does not make any difference between safety edge on opening nor on closing.

CAP ACTIVE / CAP T transmitter has 2 separate detectors, mechanical / resistive safety edge and NO-TOUCH function. Both program together and at the same time as if they were a single safety edge on the receiver. It is necessary to see the LED indicators on CAP ACTIVE / CAP T to know which kind of technology is either detecting a collision (safety edge) or prevent the collision (NO-TOUCH function)

Before programming, place the options selectors at the desired position. Any subsequent change will require a receiver reset and reprogramming.

Press the PROG button on receiver and hold it until the desired mode is selected. LED's for R1 & R2 will light up or flash in sequence to select the correct operation mode.

There are **four programming modes**, depending on the inputs you wish to use of the transmitter and the outputs required to activate on the receiver.

The receiver allows the programming 6 safety edges (3 for Relay 1 and 3 for Relay 2). A safety edge can only be programmed to one receiver.

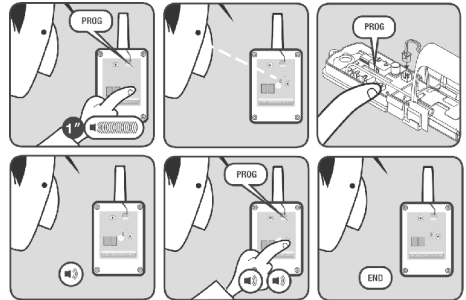

MODES	
1	IN1 → R1 Safety edge in IN1 on transmitter activates R1 on receiver
2	IN1 → R2: Safety edge in IN1 on transmitter activates R2 on receiver
3	IN1 → R1+R2: Safety edge in IN1 on transmitter activates R1 and R2 on receiver
4	IN1 → R1 and IN2 → R2: Safety edge in IN1 on transmitter activates R1 on receiver and Safety edge in IN2 on transmitter activates R2 on receiver

In case of CAP ACTIVE/CAP T, safety edge is IN1 and NO TOUCH function is IN2



EN

6.1.1 MODE 1: SAFETY EDGE CONNECTED TO IN1 ACTIVATES R1

Safety edge connected in IN1 will activate R1.

Receiver memory used = 1 transmitter.

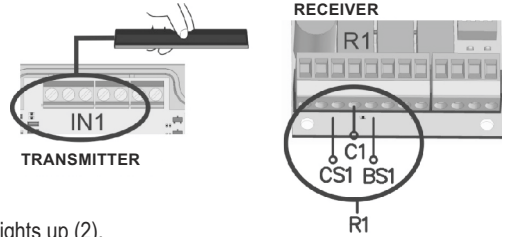

Programming sequence:

- Press PROG button on the receiver (1) until R1 LED lights up (2).
- Press PROG button on the transmitter (3).
- A beep will be heard on the receiver indicating the transmitter is properly programmed (4).

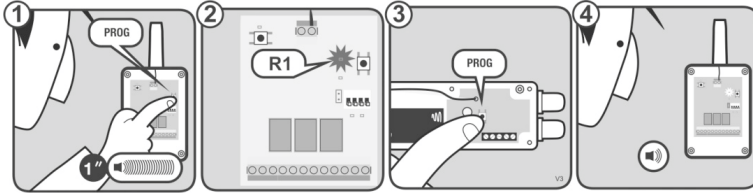

To exit programming mode, wait for 10 seconds or press PROG button on the receiver. Two beeps will be heard.

6.1.2 MODE 2: SAFETY EDGE CONNECTED TO IN1 ACTIVATES R2

Safety edge connected in IN1 will activate R2.

Receiver memory used = 1 transmitter.

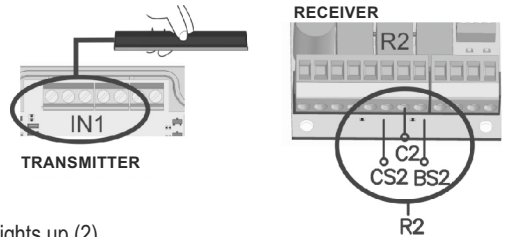

Programming sequence:

- Press PROG button on the receiver (1) until R2 LED lights up (2).
- Press PROG button on the transmitter (3).
- A beep will be heard on the receiver indicating the transmitter is properly programmed (4).

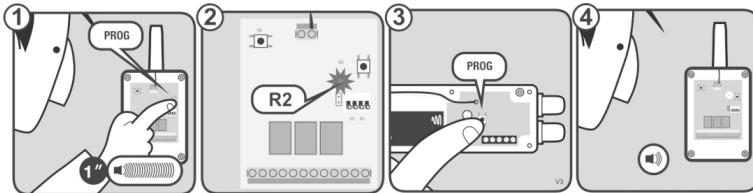

To exit programming mode, wait for 10 seconds or press PROG button on the receiver. Two beeps will be heard.

6.1.3 MODE 3: SAFETY EDGE CONNECTED TO IN1 ACTIVATES R1 AND R2

Safety edge connected in IN1 will activate R1 and R2.
Receiver memory used = 2 transmitters.

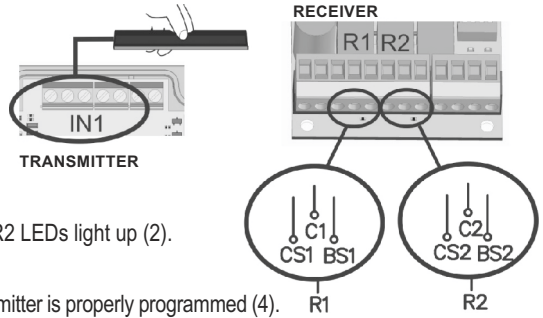

Programming sequence:

- Press PROG button on the receiver (1) until R1 and R2 LEDs light up (2).
- Press PROG button on the transmitter (3).
- A beep will be heard on the receiver indicating the transmitter is properly programmed (4).

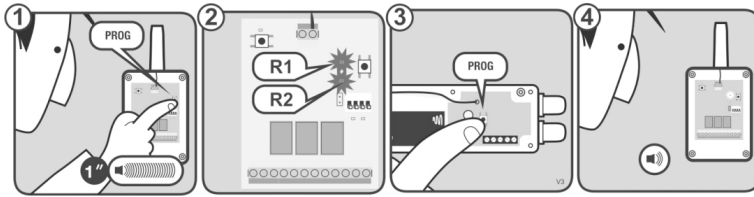

To exit programming mode, wait for 10 seconds or press PROG button on the receiver. Two beeps will be heard.

6.3.4 MODE 4: SAFETY EDGE CONNECTED TO IN1 ACTIVATES R1 AND SAFETY EDGE CONNECTED TO IN2 ACTIVATES R2

Safety edge connected in IN1 will activate R1 and IN2 will activate R2.
Receiver memory used = 2 transmitters.

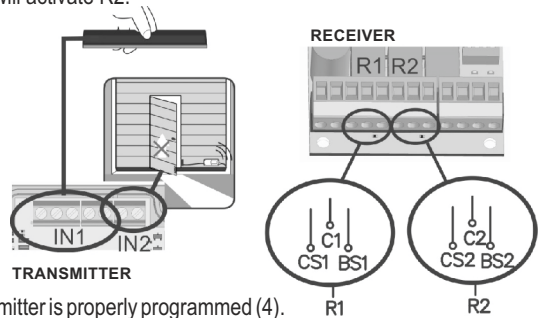

Programming sequence:

- Press PROG button on the receiver (1) until R1 LED and R2 LED begin to flash (2).
- Press PROG button on the transmitter (3).
- A beep will be heard on the receiver indicating the transmitter is properly programmed (4).

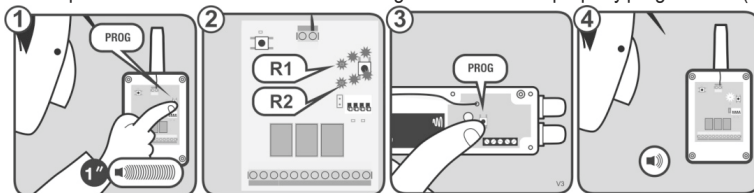

To exit programming mode, wait for 10 seconds or press PROG button on the receiver. Two beeps will be heard.

EN

7 - CHANGING SIZE OF THE SAFETY EDGE

7.1 - REMOVING SAFETY EDGE

Insert the supplied locking pin to suspend the movement of the cam (a)

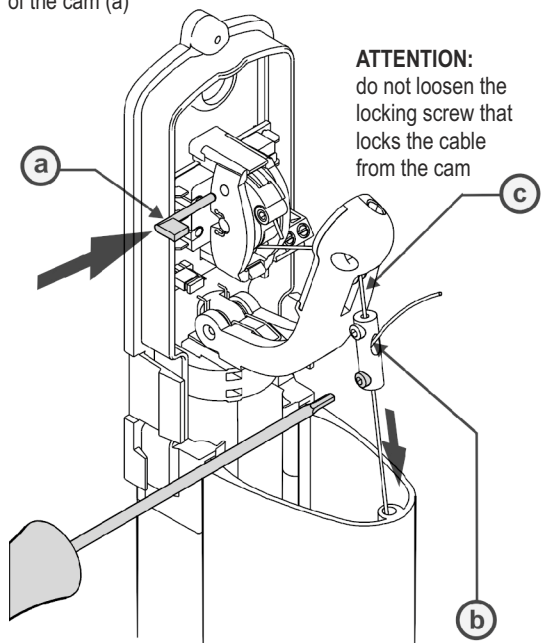

ATTENTION:
do not loosen the locking screw that locks the cable from the cam

Unscrew the locking screw (b) that locks the cable coming out from the lower part of the edge

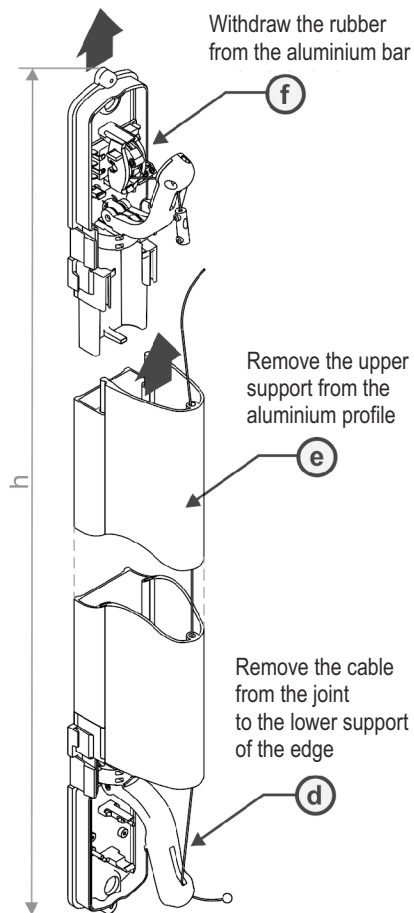

Withdraw the rubber from the aluminium bar

Remove the upper support from the aluminium profile

Remove the cable from the joint to the lower support of the edge

7.2 - CHANGING SIZES

EXAMPLE to get an edge of: MBS = 1800 mm

Extruded rubber: MBS mm -245 mm (cut) = 1555 mm

Aluminium profile: MBS mm -285 mm (cut) = 1515 mm

7.3 - SAFETY EDGE INSTALLATION

- 1 Slide the rubber in the aluminium profile(g)

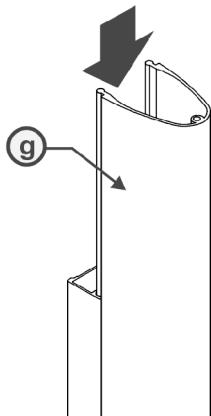

- 2 When you have finished, the rubber edge should overhang over 20mm compared to the aluminium profile (i)

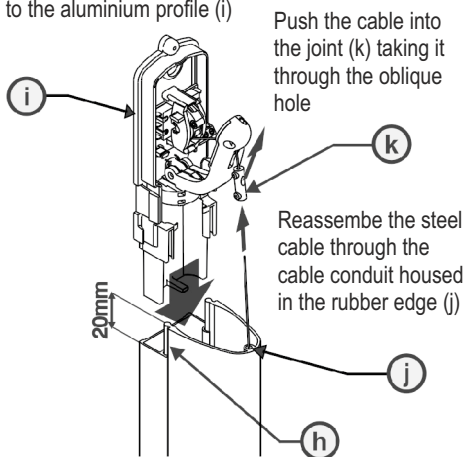

- 3 Keeping tension on the steel cable, clamp the locking screw in this joint (l)

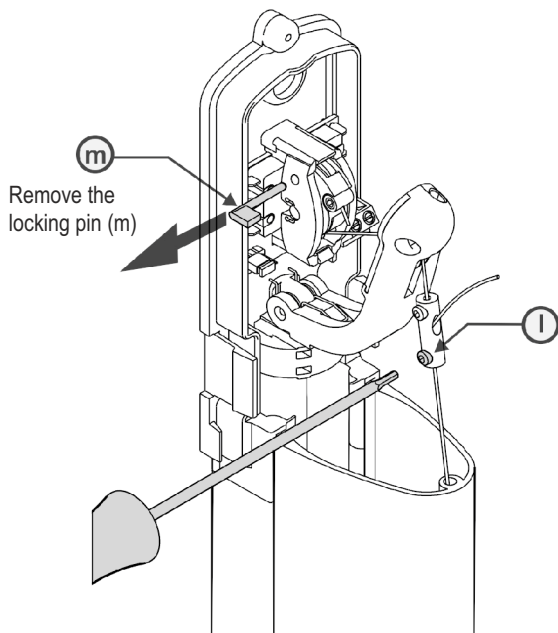

Proceed to the "Cable tension and calibration" according to point 3.2.1
 Proceed to the "Positioning of the cap" according to point 3.2.2

EN

8 - CHECKING AND MAINTENANCE

8.1 - DOES THE EQUIPMENT WORK PROPERLY?

Once the safety edge is wired and programmed into the receiver, R1 and / or R2 (according to programming mode) are not illuminated (OFF). Also IN1 and IN2 LEDs at the transmitter are at OFF.

If the safety edge has been programmed in R1 and R1 LED is at ON, check that the safety edge is not pushed/detecting (IN1 LED at ON on the transmitter) or it is not properly configured (IN1 LED flashing on the transmitter). If IN1 LED is at OFF and R1 LED is at ON, check status of other transmitters memorised.

The IN1 and IN2 LEDs of the transmitter will switch to battery saving mode (off) 5 minutes after pressing PROG on the transmitter. They can re-awaken again pressing the PROG button on the transmitter.

If there is no safety edge programmed in R1 and/or R2, then safety mode will be operational (opened and LED at ON).

If R1 / R2 LEDs are OFF, but the gate does not move, check that the wiring to the control panel is made correctly as safety contact or resistive safety edge input.

Check also if LED indicator on MAGIN detector changes to red color in the desired inhibition zone, and the INH LED on the receiver is switched ON.

8.2 - CHECK THE CORRECT OPERATION

Press the safety edge to assure that the appropriate relay on the receiver is activated.











If not, see the Troubleshooting table, to check what is happening and how to solve it.

8.3 - CHECK FUNCTION

Ideal to know the radio coverage on the installation.

Press the receiver's CHECK button for at least 1 second to enter check mode. The indicator light will come on and four beeps will be heard.

Perform a complete door opening and closing manoeuvre. During the system check a beep will be heard every 1.5 seconds. If no other acoustic signal is heard on completing the manoeuvre, the system is operating correctly. If the communication with a transmitter fails during checking, or the communication is deficient, the receiver emits three consecutive beeps, indicating that an error has occurred.

	N° flashes check LED	Signal coverage	Result of check
		Very weak	Safety edge failure
		Weak	OK
		Normal	OK
		Good	OK
		Very good	OK

Press the installed safety edges to detect which one has failed.

Low coverage signal will increase battery consumption.

For exiting CHECK mode, press CHECK button or wait for 5 minutes. On exiting check mode, seven consecutive beeps will be heard and the indicator light will flash continuously in case of failure.

This function has to be used to check the operation and range of all the devices once the installation has been carried out.

8.4 - TROUBLESHOOTING

Press the PROG button to display the status of the LEDs on the transmitter CAP T

CAP R			CAP T	MESSAGE / ERROR	SOLUTION
R1/R2 LED	ATEST LED	BEEPS	IN1/IN2 LED		
				Detection of the safety edge	Verify that the IN1/IN2 LED of the CAP T is at ON when you press PROG button of the CAP T, to check the correct operation.
				Receiver with another transmitter in memory.	Check the IN1/IN2 status of all CAP T installed. RESET memory and reprogram to ensure not having other transmitters in memory.
				Communication failure between CAP R and CAP T.	Verify the radio signal with the CHECK function.
				The safety edge is not detected correctly (not connected or not programmed) or the position of the selector is incorrect.	Reset the system, Connect correctly, check selector or program the safety edge transmitter into the receiver.
		4x / 5s		CAP T low battery or communication loss between equipments.	Verify the batteries of the transmitter and/or the presence of interferences (CHECK function).
				CAP T receiver is in WORK mode waiting for TEST signal.	---
				CHECK function. See coverage and signal quality table.	---
---	---	1x / 4x	---	Receiver memory full. Indication when trying to memorize a new transmitter.	Reset the system and reprogram the equipment. Maximum 6 safety edges per receiver (3 per relay).
---	---	7x	---	Change of operating mode in the CAP R with transmitters already memorized.	Reset the system, change SW2 on the receiver to the desired position and reprogram the equipments.

EN

8.5 - TOTAL RESET

Press PROG button on the receiver (1) until the R1 LED lights on (2).

Keep the programming PROG button pressed down and make a bridge with the "MR" reset jumper (3).

The receiver will emit 10 warning sound signals (3), and then more at a faster frequency, indicating that the operation has been carried out (4).

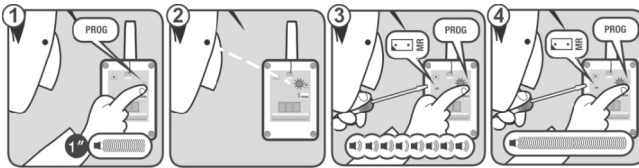

To exit programming mode, wait for 10 seconds or press PROG button on the receiver. Two beeps will be heard.

8.6 - BATTERIES

Replacing the CAP ACTIVE transmitter battery

- Remove the end cap of the band where the batteries are located
- Remove the battery holder from the velcro strip, by prying with a screwdriver or similar.

Replace the two used batteries with the new ones, taking into account the polarity indicated by the connector.

Check that the new batteries support the same temperature range as those they are replacing.

- Then put the battery holder inside the cavity and fix it with the velcro strip.

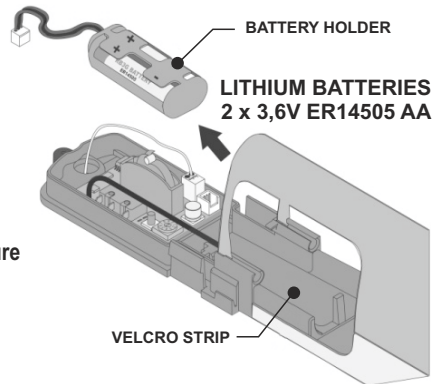

Storage

- Store the lithium cells in a cool, dry and ventilated area far from fires and heating sources.
- It is recommended the use of a non-combustible structure and keep adequate clearance between walls and batteries.
- The maximum temperature suggested for the storage is +30°C.
- Higher temperatures are allowed but cause an increase in the self discharge of the battery and speed up the process of passivation.
- In any case, never go over 100°C, as the batteries can break and cause a leakage.
- Arrange adequate protections to avoid possible damages to the batteries.
- Keep the batteries in their original packages until they are used.
- Do not expose the batteries directly to the sun light.
- Do not stack a high number of cartons on top of each another (respect what is indicated).
- If storing batteries with a total capacity >50,000Ah in the same place, it is suggested to install an alarm for smoke and gas.

Usage

- If the battery is integral, store and handle with care (it is suggested to handle the batteries in a ventilated place, do not smoke, eat or drink during the assembly).
- Do not expose at temperature higher than 100°C (it is recommended <85°C).
- Avoid short circuit, crush, and exposition to heat sources.
- Do not disassemble the batteries or the battery packs, do not throw them in the fire, do not perforate them, do not overheat or wet them.
- Material to avoid: water, oxidizing agents, alkalis.

Battery life (years)	CAP ACTIVE (mechanical safety edge) Number of manoeuvres/day				
	300	100	50	25	10
Manoeuvre duration (seconds)					
10	2,43	2,91	3,06	3,14	3,19
30	1,63	2,43	2,77	2,98	3,12
50	1,23	2,09	2,54	2,84	3,06
100	0,76	1,55	2,09	2,54	2,91
300	0,30	0,76	1,23	1,78	2,43

Battery life (years)	CAP T (8k2 safety edge) Number of manoeuvres/day				
	300	100	50	25	10
Manoeuvre duration (seconds)					
10	1,05	1,79	2,16	2,42	2,60
30	0,47	1,05	1,52	1,96	2,36
50	0,30	0,75	1,17	1,64	2,16
100	0,16	0,43	0,75	1,17	1,79
300	0,06	0,16	0,30	0,55	1,05

9 - TECHNICAL DATA SUMMARY

	CAP ACTIVE 868	CAP T868 / CAP T916
Frequency	Multifrequency system 868 MHz	Multifrequency system 868 MHz / Multifrequency system 916 MHz
Operating consumption	2.1 mA	12 mA
Radiated power	< 25 mW	< 25 mW
Range (in open field)	50 m	50 m
Operating temperature	from -10°C to +55°C	from -20°C to +55°C
Watertightness	IP54	IP65
Reaction time (typical)	- - -	35 ms
Pre-run / After-run	18 mm / 24 mm	- - -
Maximum bearing speed	12 m / min	- - -
Response time with feed 12 m/min	> 0,15 s	- - -
Response time with feed 0.6 m/min	> 2 s	- - -
Distortion recovery time	< 2 s	- - -
Maximum safety edge length	2.5 m	2.5 m

The manufacturer reserves the right to change the specification of the equipment without prior warning

10 - MAINTENANCE REGISTER

CAP ACTIVE safety edge does not need special maintenance, yet a periodic check (every 6 months) is recommended. Each check must be registered.

It is recommended to remove any extraneous substances cleaning with exhausters. Check for presence and legibility of the product identification marking.

EN

11 - IMPORTANT SAFETY INSTRUCTIONS

Disconnect the power supply whenever you proceed to the installation or repair of the control panel. In accordance with the European low voltage directive, you are informed of the following requirements:

- For permanently connected equipment, an easily accessible connection device must be incorporated into the cabling.
- This system must only be installed by a qualified person that has experience with automatic doors/gates and knowledge of the relevant EU standards.
- The instructions for use of this equipment must always remain in the possession of the user.
- The frequency of the RadioBand system does not interfere in any way with the 868 MHz remote control systems.

Follow all recommendations given in this manual to prevent serious danger to people.

EC Declaration of conformity

The manufacturer:

GI.BI.DI. S.r.l.
Via Abetone Brennero, 177/B
46025 Poggio Rusco (MN) - ITALY

hereby declares that the products:

CAP ACTIVE - CAP T868/916 - CAP R868/916 - CAP MAGIN

comply with the requirements of the following EEC directives:

- 2014/53/EW Directive - RED
- 2011/65/UE Directive - ROHS
- 2014/30/EU Directive - Electromagnetic compatibility
- 2014/35/EU Directive - Low voltage

In order to comply with the EN 12978:2003 product standard and assure the correct operation of the system, it is mandatory to follow the instructions below, to avoid serious dangerous to persons.

- **SW1:1 is allowed to be set at ON, only if the door cycle is between 7s and 30s.**
- **SW1:1 is allowed to be set at OFF, only if the door cycle is greater than 30s.**

Note: If the door cycle is smaller than 7s, the system must be used only in WORK mode

The system complies with EN ISO 13849-1:2015, category 2, PLd.

Date 06/06/2022

The Legal Representative
Michele Prandi





GI.BI.DI. S.r.l.

Via Abetone Brennero, 177/B
46025 Poggio Rusco (MN) - ITALY
Tel. +39.0386.52.20.11
Fax +39.0386.52.20.31
E-mail: info@gibidi.com

Numero Verde: 800.290156

www.gibidi.com