



ACCESSORI.

G:B:D:
CREATIVE AUTOMATIONS

ACCESSORI





ACCESSORI.

GIBIDI
CREATIVE AUTOMATIONS

MAKO

Un nuovo concetto di eleganza. Il nuovo radiocomando GIBIDI per aprire le porte del vostro futuro.

Linee eleganti, pulsanti ergonomici e di facile utilizzo, LED di segnalazione ed aggancio per il portachiavi ricavato direttamente dall'anima realizzata in robusto alluminio pressofuso. Guscio prodotto con i più moderni tecnopolimeri ed al suo interno, tutta la tecnologia GIBIDI.

Elettronica innovativa realizzata con i più alti standard tecnologici per garantire, grazie al sistema HPA

(High Protection Algorithm), affidabilità, sicurezza e potenza del segnale, sempre!

Disponibile anche con elettronica MANAGER per una gestione degli accessi evoluta e non clonabile! MAKO con MANAGER, il binomio della sicurezza.

MAKO: il nuovo modo di servirsi della tecnologia più avanzata.

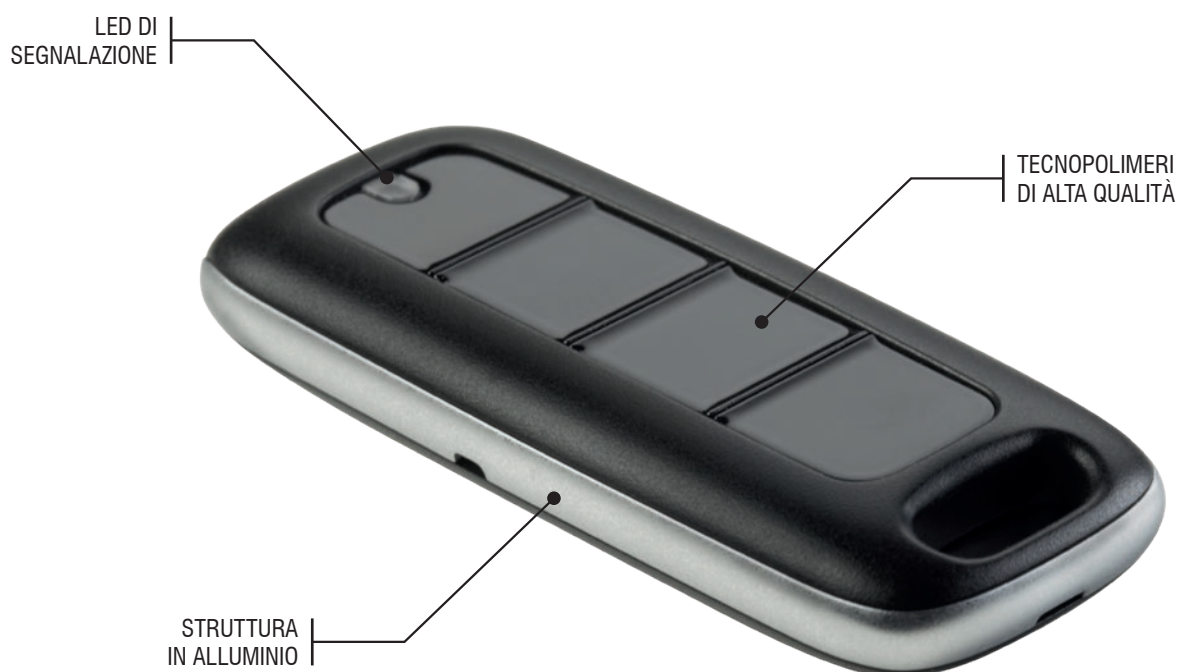

GIBIDI
CREATIVE AUTOMATIONS



GIBIDI S.r.l.
Via Abetone Brennero, 177/B
46025 Poggio Rusco (MN) - ITALY
Tel. +39.0386.52.20.11
Fax +39.0386.52.20.31
info@gibidi.com
www.gibidi.com



ACCESSORI.

GIBIDI
CREATIVE AUTOMATIONS

DOMINO

Domina ogni tipo di impianto con la facilità di un semplice gesto che tocca un oggetto di alto design.

DOMINO è facile da usare, grazie ai tasti ergonomici, piccolo (ma non troppo) e affidabile. Potrete agganciarlo al vostro portachiavi, oppure fissarlo in automobile utilizzando il sistema di fissaggio incluso.

Grazie ai simpatici accessori potrete personalizzare il vostro radiocomando con un colore a vostra scelta fra quelli disponibili. Le cover colorate possono essere cambiate in pochi secondi.

DOMINO: il modo più moderno di servirsi della sicurezza più avanzata.

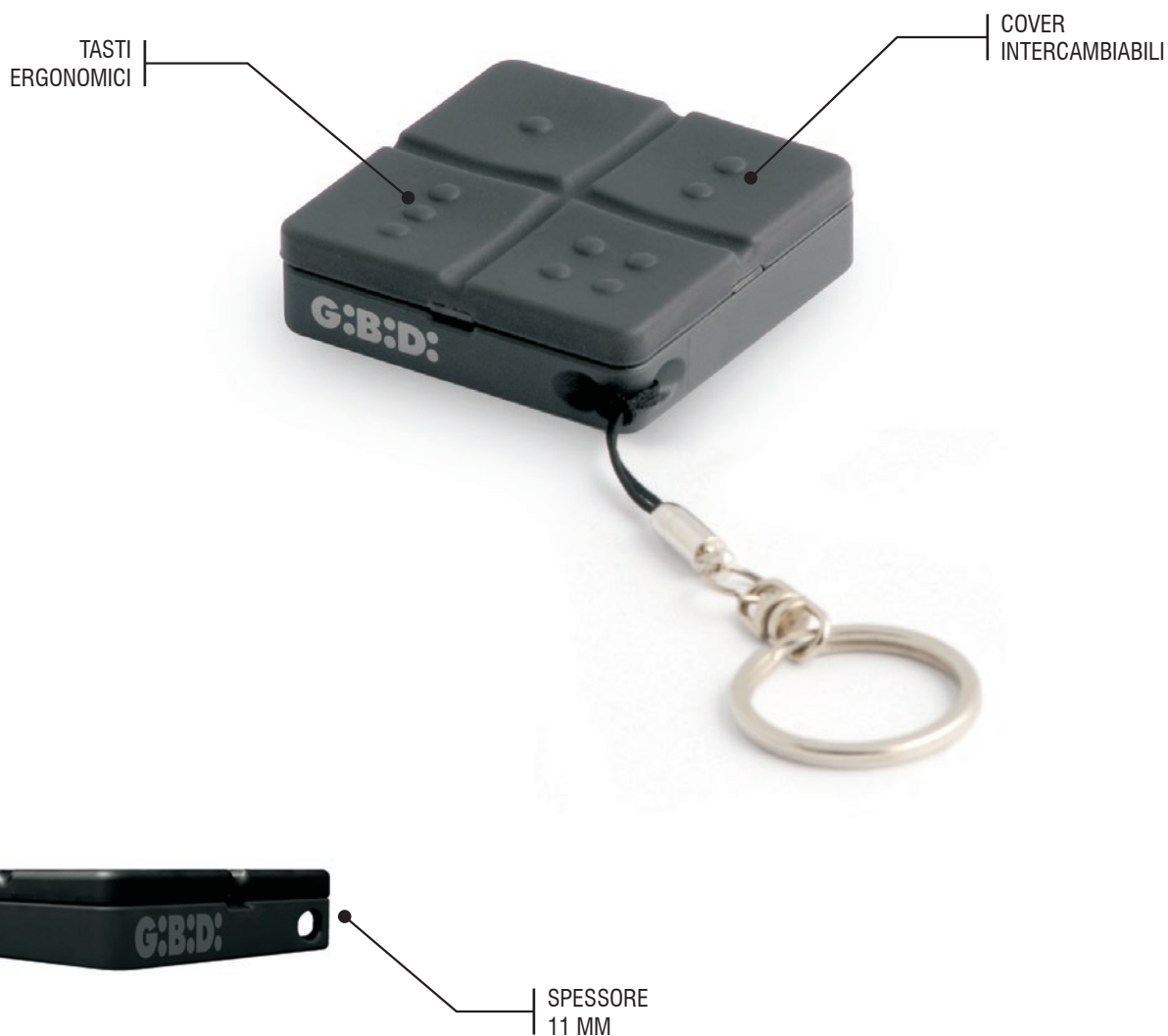

GIBIDI
CREATIVE AUTOMATIONS



G.I.B.I.D.I. S.r.l.
Via Abetone Brennero, 177/B
46025 Poggio Rusco (MN) - ITALY
Tel. +39.0386.52.20.11
Fax +39.0386.52.20.31
info@gibidi.com
www.gibidi.com



ACCESSORI.

GIBIDI
CREATIVE AUTOMATIONS

MANAGER

Il programmatore facile da usare che permette la gestione completa di tutti gli impianti realizzati con dispositivi della serie MANAGER.

La possibilità di gestione tramite PC ne rende l'utilizzo ancora più semplice e accattivante.

La soluzione offerta da GIBIDI a chiunque voglia rendere l'impianto di propria esclusiva pertinenza.

La programmazione dei dispositivi avviene in modalità WIRELESS.

MANAGER consente di programmare dispositivi trasmettenti e riceventi sia a radiofrequenza che a transponder, gestendo modalità di funzionamento, personalizzazioni, autorizzazioni, modifiche ed anche l'innovativo sistema anti-clonazione sempre in modalità di sicurezza (ROLLING-CODE).



GIBIDI
CREATIVE AUTOMATIONS

G.I.B.I.D.I. S.r.l.
Via Abetone Brennero, 177/B
46025 Poggio Rusco (MN) - ITALY
Tel. +39.0386.52.20.11
Fax +39.0386.52.20.31
info@gibidi.com
www.gibidi.com





ACCESSORI.

GIBIDI

CREATIVE AUTOMATIONS

GIOTTO

Per tutti quelli che amano portare sempre con sé il proprio radiocomando, ecco GIOTTO! Il nuovo radiocomando bicanale tascabile e senza spigoli. Le sue dimensioni ridotte con grandi tasti, lo rendono facilmente utilizzabile ma discreto allo stesso tempo.

Dotato di tecnologia HPA (High Protection Algorithm) permette di essere usato in totale sicurezza.

GIOTTO è anche potente e grazie alle migliori tecnologie è in grado di aprire e chiudere il vostro cancello automatico anche da grandi distanze.

GIOTTO è completamente compatibile con la serie MAKO e DOMINO rolling code.



GIBIDI
CREATIVE AUTOMATIONS



GIBIDI S.r.l.
Via Abetone Brennero, 177/B
46025 Poggio Rusco (MN) - ITALY
Tel. +39.0386.52.20.11
Fax +39.0386.52.20.31
info@gibidi.com

www.gibidi.com



ACCESSORI.

GIBIDI
CREATIVE AUTOMATIONS

DSL

Ecco un altro tassello della piacevolezza moderna applicata, con intelligenza progettuale, ad un lampeggiante.

Grazie alla modularità ed estrema facilità d'installazione, la radio ricevente e l'antenna si integrano rapidamente in un solo prodotto.

Basterà scegliere il tipo di scheda di lampeggio per ottenere un prodotto completo.

Se decidi di utilizzare la radio ricevente al suo interno, la memorizzazione dei trasmettitori sarà facilitata dai comandi posizionati direttamente sul contenitore.

DSL: il nuovo segno distintivo del vostro cancello automatico.

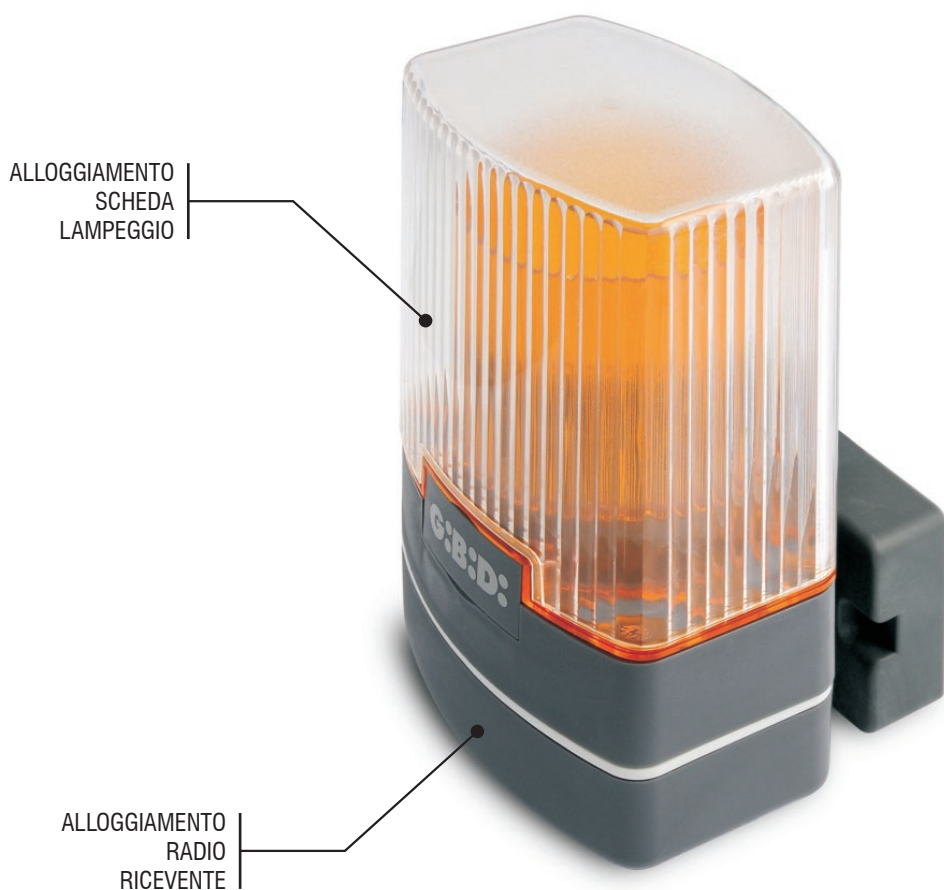

GIBIDI
CREATIVE AUTOMATIONS



GIBIDI S.r.l.
Via Abetone Brennero, 177/B
46025 Poggio Rusco (MN) - ITALY
Tel. +39.0386.52.20.11
Fax +39.0386.52.20.31
info@gibidi.com
www.gibidi.com



ACCESSORI.

GIBIDI
CREATIVE AUTOMATIONS

DRR

Un nuovo contenitore per ricevitori radio adatto per installazione esterna.

Grazie all'estrema modularità è possibile eseguire il fissaggio sia sulla parete che sopra a pilastri o muri.

Nella confezione è compreso l'adattatore per poter installare l'antenna da esterno direttamente sul contenitore.

Un nuovo design per un prodotto semplice e funzionale.



GIBIDI
CREATIVE AUTOMATIONS



GIBIDI S.r.l.
Via Abetone Brennero, 177/B
46025 Poggio Rusco (MN) - ITALY
Tel. +39.0386.52.20.11
Fax +39.0386.52.20.31
info@gibidi.com
www.gibidi.com



ACCESSORI.

GIBIDI
CREATIVE AUTOMATIONS

DC

La nuova linea accessori GIBIDI, colonnine, fotocellule e selettori da parete.

Una linea concepita per essere adattabile ad ogni esigenza installativa ed estetica, un sistema brevettato che racchiude la tecnologia, il design e praticità di installazione.

Un sistema estremamente modulare che consente una facile messa in opera e manutenzione.

La giusta soluzione per completare il vostro ingresso automatico.

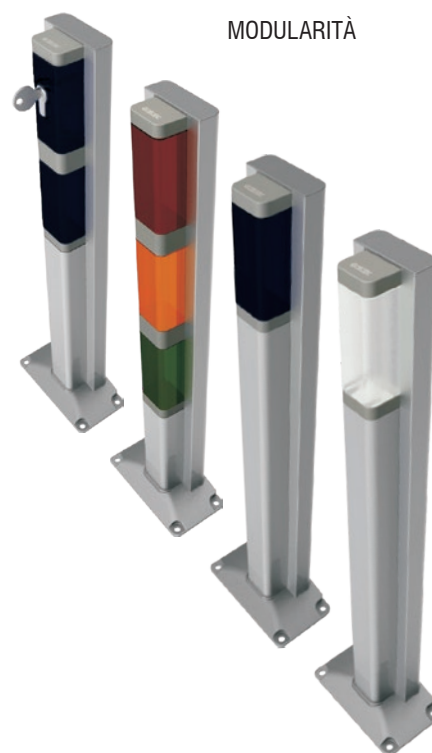
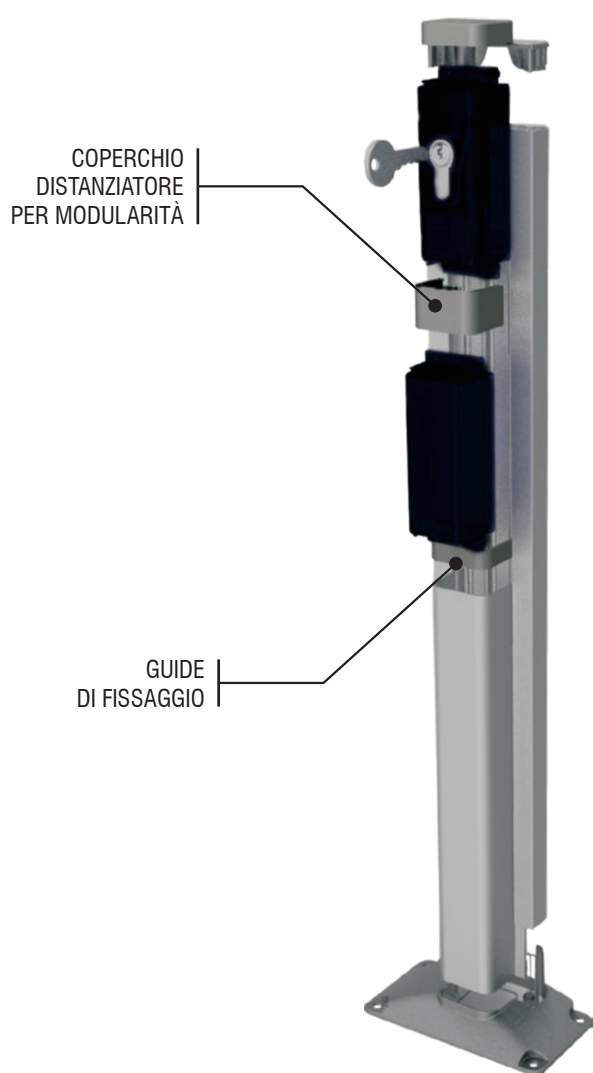

GIBIDI
CREATIVE AUTOMATIONS

G.I.B.I.D.I. S.r.l.
Via Abetone Brennero, 177/B
46025 Poggio Rusco (MN) - ITALY
Tel. +39.0386.52.20.11
Fax +39.0386.52.20.31
info@gibidi.com

www.gibidi.com





ACCESSORI.

GIBIDI
CREATIVE AUTOMATIONS

DG

La linea accessori GIBIDI, colonnine, fotocellule e selettori, da incasso e da parete.

Una linea adattabile ad ogni esigenza installativa, che racchiude tecnologia e praticità di installazione.

Un sistema modulare che consente una facile messa in opera e manutenzione.

Un'ulteriore soluzione per completare il vostro ingresso automatico.

CILINDRO
PROFILO EUROPEO

COLONNINA
IN ALLUMINIO

GUIDE
DI FISSAGGIO

MODULARITÀ

IP54

GIBIDI
CREATIVE AUTOMATIONS

G.I.B.I.D.I. S.r.l.
Via Abetone Brennero, 177/B
46025 Poggio Rusco (MN) - ITALY
Tel. +39.0386.52.20.11
Fax +39.0386.52.20.31
info@gibidi.com
www.gibidi.com





ACCESSORIES.

G:B:D:
CREATIVE AUTOMATIONS

ACCESSORIES





ACCESSORIES.

GIBIDI
CREATIVE AUTOMATIONS

MAKO

A new concept of elegance. The new GIBIDI transmitter to open the doors of your future.

Smart lines, ergonomic buttons easy to use, signalling LED and a hooking for the key ring directly inserted in the die-cast aluminium structure. The casing is produced from the most modern techno-polymers providing protection to the GIBIDI equipment inside.

Innovative electronics made with the highest technologic standards to always grant reliability, safety and signal power,

thanks to the HPA system (High Protection Algorithm)!

Available also with MANAGER electronics for an evolved management of the access, that cannot be cloned! MAKO with MANAGER, the safety binomial.

MAKO: the new way of using the most advanced technology.

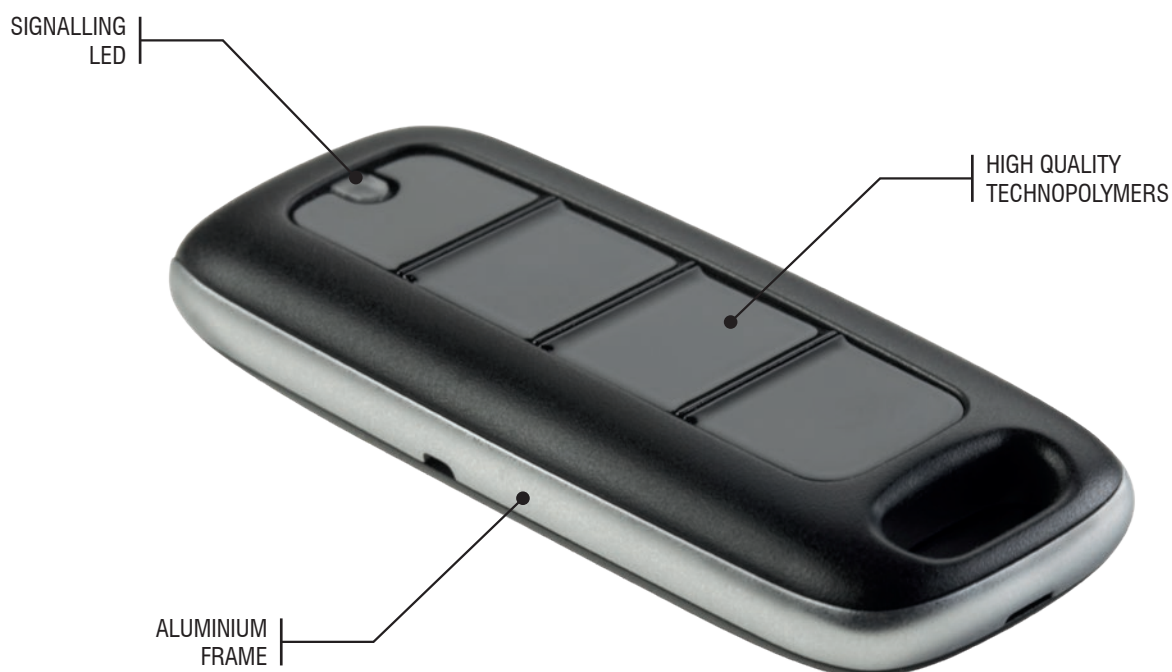

GIBIDI
CREATIVE AUTOMATIONS



GI.BI.DI. S.r.l.
Via Abetone Brennero, 177/B
46025 Poggio Rusco (MN) - ITALY
Tel. +39.0386.52.20.11
Fax +39.0386.52.20.31
info@gibidi.com
www.gibidi.com



ACCESSORIES.

GIBIDI
CREATIVE AUTOMATIONS

DOMINO

It dominates every type of system with the ease of a simple gesture that touches a high design object.

DOMINO is easy to use, thanks to the ergonomic buttons, small (but not too much) and reliable. You can attach it to your key ring, or fix it in the car using the included fastening system.

Thanks to the nice accessories you can customize your remote control with a color of your choice from those available. The colored covers can be changed in seconds.

DOMINO: the most modern way to use the most advanced security.

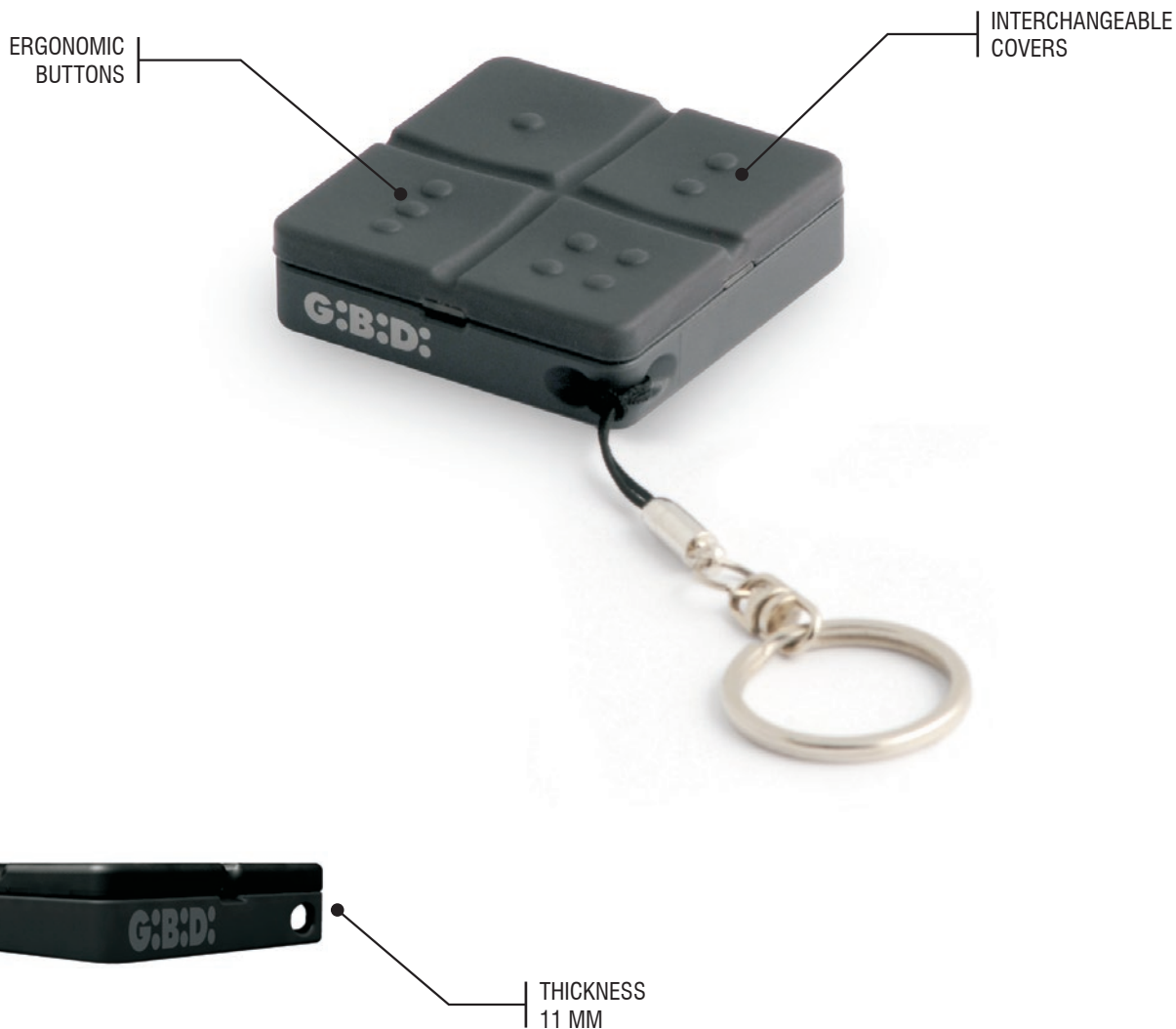

GIBIDI
CREATIVE AUTOMATIONS



GIBIDI S.r.l.
Via Abetone Brennero, 177/B
46025 Poggio Rusco (MN) - ITALY
Tel. +39.0386.52.20.11
Fax +39.0386.52.20.31
info@gibidi.com
www.gibidi.com



MANAGER

The programmer easy to use that allows the complete management of all the installations made with MANAGER series devices.

The possibility to manage the system by PC makes it easy to use and flexible.

The solution offered by GIBIDI to all customers who want to make the installation their own domain.

The system programming is done in WIRELESS technology.

MANAGER allows the user to program transmitting and receiving devices both at radio frequency and at transponder and to manage functionality, customization, authorisation, modification and also the innovatory system anti-cloning always in safety modality (ROLLING-CODE).

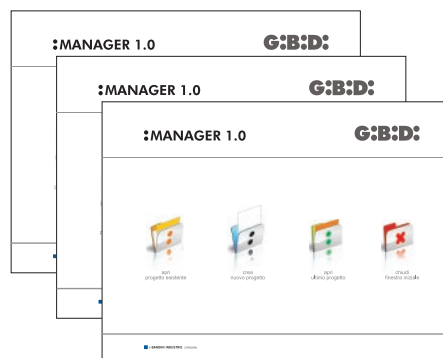



GIOTTO

For all those who love to always carry their own remote control, here is GIOTTO! The new pocket-sized two-channel remote control without edges. Its small size with large buttons make it easy to use but discreet at the same time.

Equipped with HPA (High Protection Algorithm) technology, it can be used in total safety.

GIOTTO is also powerful and thanks to the best technologies, it is able to open and close your automatic gate even from great distances.

GIOTTO is fully compatible with the MAKO and DOMINO rolling code series.





ACCESSORIES.

GIBIDI
CREATIVE AUTOMATIONS

DSL

Yet another joy of modern technology and intelligent design applied to a flashlight.

Thanks to its modularity and extremely easy installation, the radio receiver and antenna are quickly integrated into one single product.

All you have to do is choose the type of flashlight and your product is complete.

If you decide to use the built-in radio receiver, you can store the transmitters simply by using the controls on the case.

DSL: the new hallmark of your automatic gate.

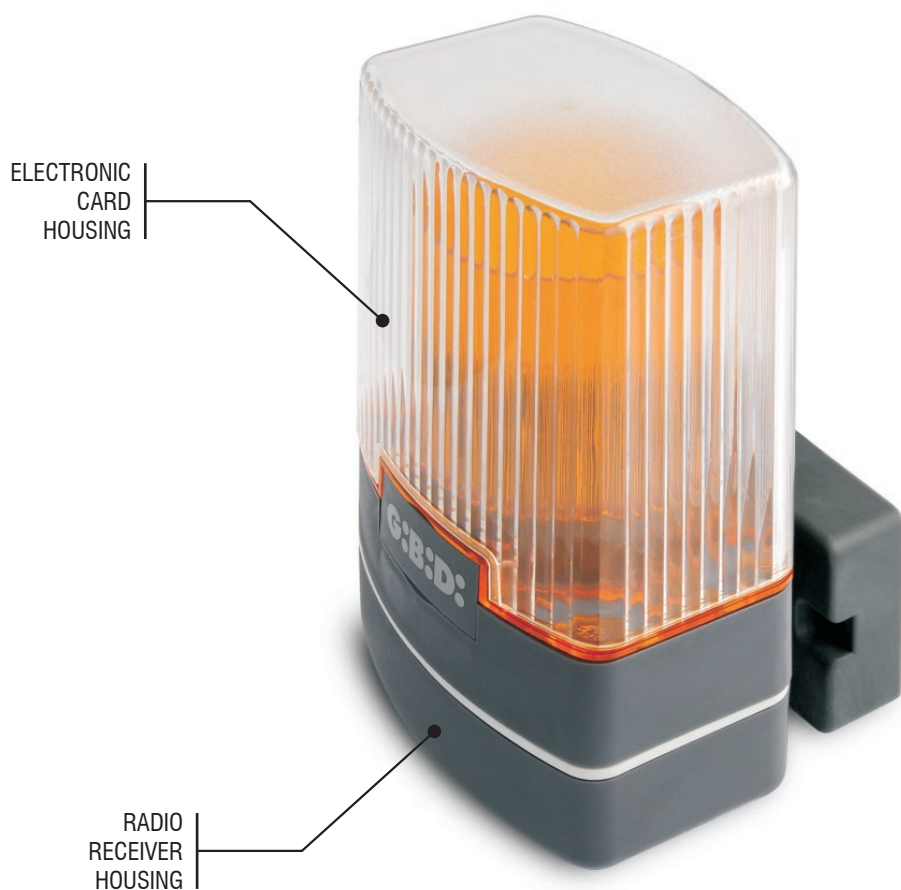

GIBIDI
CREATIVE AUTOMATIONS



G.I.B.I.D.I. S.r.l.
Via Abetone Brennero, 177/B
46025 Poggio Rusco (MN) - ITALY
Tel. +39.0386.52.20.11
Fax +39.0386.52.20.31
info@gibidi.com
www.gibidi.com



DRR

A new case for radio receivers suitable for outdoor installation.

Thanks to the extreme modularity, it can be wall-mounted or pillar-mounted.

The kit includes an adapter to install the outdoor antenna directly on the case.

A new design for a simple and functional product.





ACCESSORIES.

GIBIDI
CREATIVE AUTOMATIONS

DC

The new range of GIBIDI accessories, posts, photocells and wall-mounted key selectors.

A range designed to be adaptable to any kind of installation or aesthetic requirement, a patented system that includes technology, design and easy installation.

A modular system that allows easy setting up and maintenance.

The perfect solution to complete your automatic entrance.

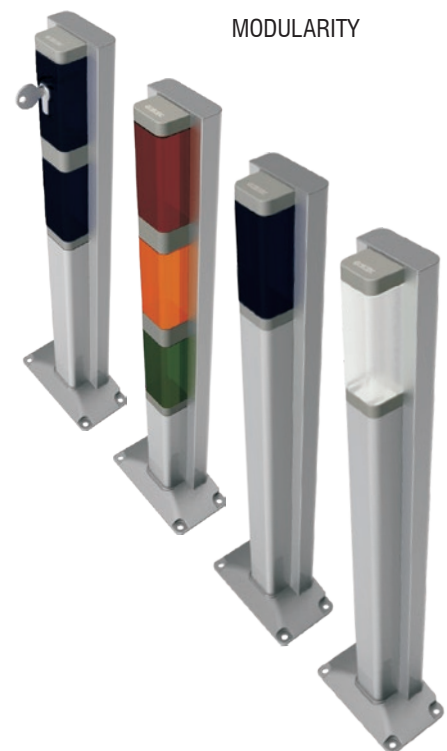
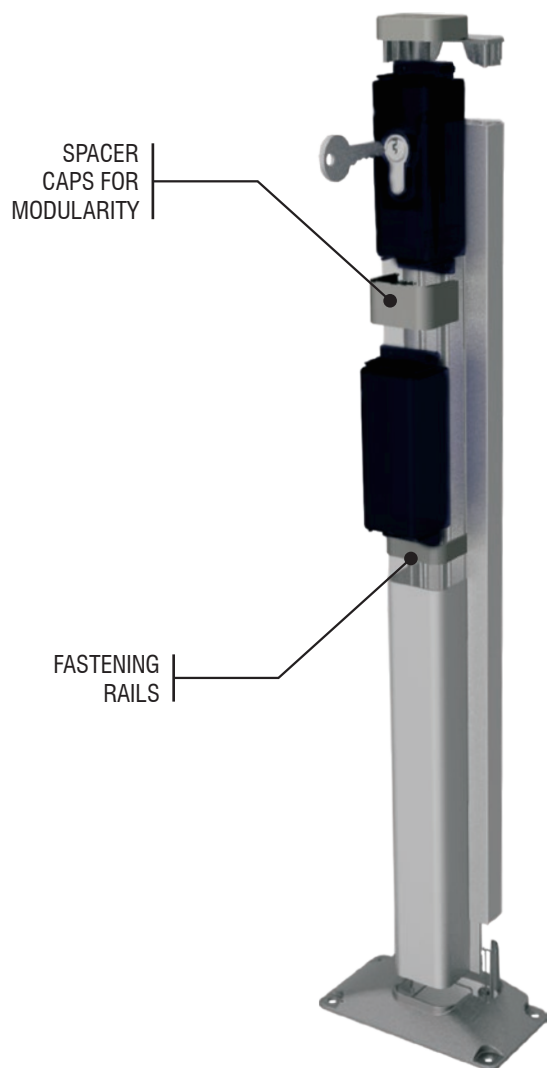

GIBIDI
CREATIVE AUTOMATIONS

G.I.B.I.D.I. S.r.l.
Via Abetone Brennero, 177/B
46025 Poggio Rusco (MN) - ITALY
Tel. +39.0386.52.20.11
Fax +39.0386.52.20.31
info@gibidi.com
www.gibidi.com





ACCESSORIES.

GIBIDI
CREATIVE AUTOMATIONS

DG

The range of GIBIDI accessories, posts, photocells and built-in or wall-mounted selectors.

A range that can be adapted to any kind of installation requirement, that includes technology and ease of installation.

A modular system that allows easy setting up and maintenance. Another solution to complete your automatic entrance.

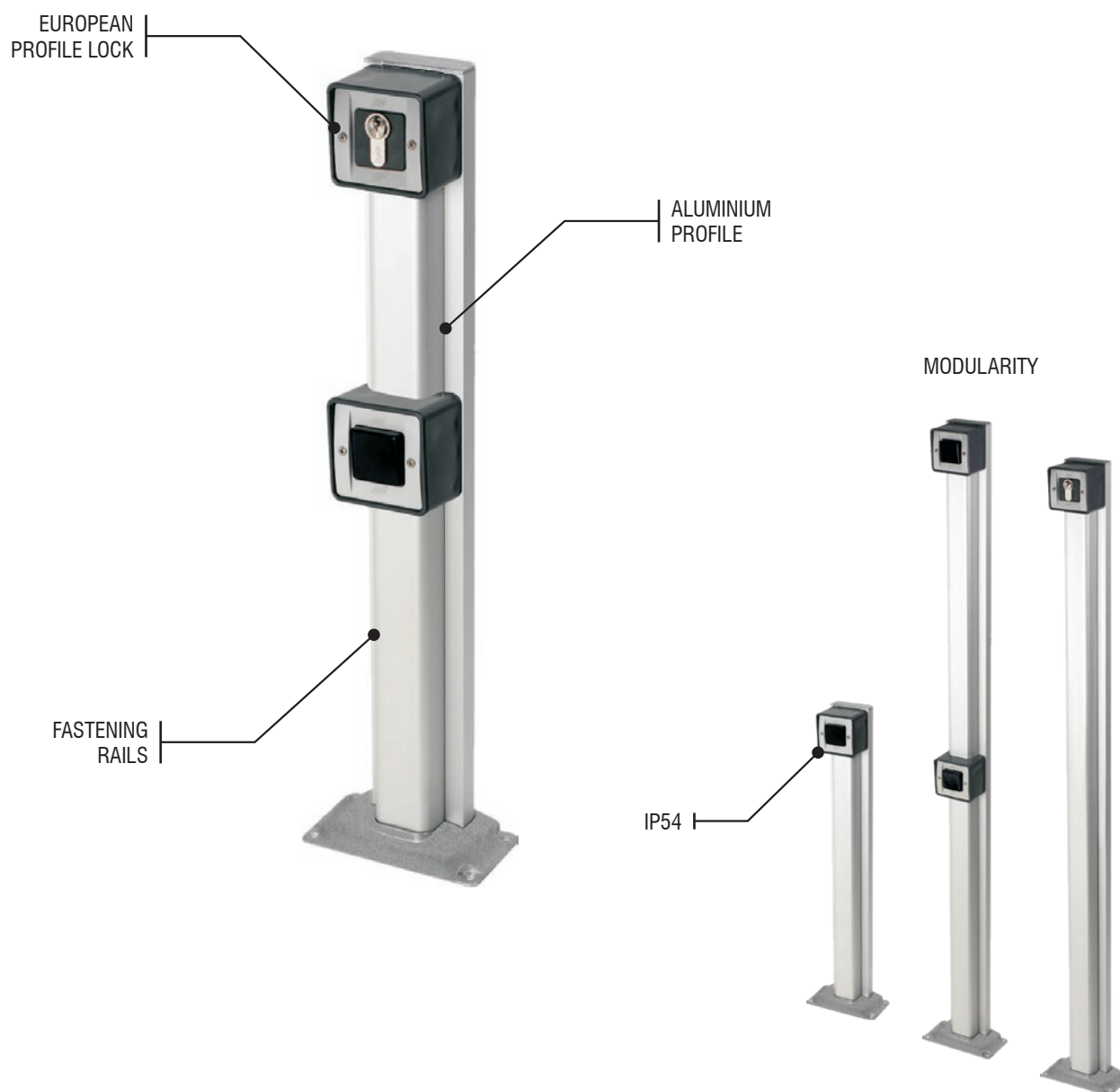

GIBIDI
CREATIVE AUTOMATIONS

G.I.B.I.D.I. S.r.l.
Via Abetone Brennero, 177/B
46025 Poggio Rusco (MN) - ITALY
Tel. +39.0386.52.20.11
Fax +39.0386.52.20.31
info@gibidi.com
www.gibidi.com





ACCESORIOS.

G:B:D:
CREATIVE AUTOMATIONS

ACCESORIOS





ACCESORIOS.

GIBIDI
CREATIVE AUTOMATIONS

MAKO

Un nuevo concepto de elegancia. El nuevo mando GIBIDI para abrir las puertas de vuestro futuro.

Líneas elegantes, botones ergonómicos y de fácil utilización, LED de señalización y enganche para el llavero insertado directamente en la estructura de robusto aluminio fundido a presión. Caja producida con los más modernos tecnopolímeros y, al interior, toda la tecnología GIBIDI.

Electrónica innovadora realizada con los más altos estándares tecnológicos para garantizar siempre fiabilidad, seguridad y

potencia de la señal gracias al sistema HPA (High Protection Algorithm).

Disponible también con electrónica MANAGER para una gestión de accesos avanzada, que ino se puede clonar! MAKO y MANAGER, el binomio de la seguridad.

MAKO: la nueva manera de valerse de la tecnología más avanzada.

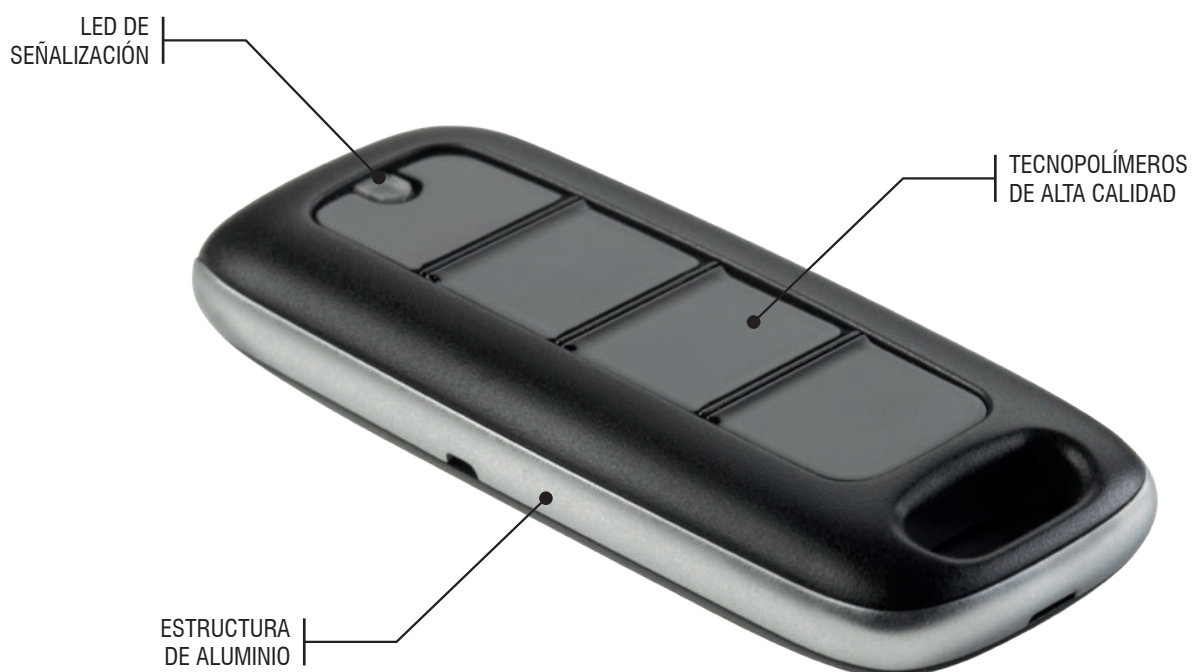

GIBIDI
CREATIVE AUTOMATIONS



GIBIDI S.r.l.
Via Abetone Brennero, 177/B
46025 Poggio Rusco (MN) - ITALY
Tel. +39.0386.52.20.11
Fax +39.0386.52.20.31
info@gibidi.com

www.gibidi.com



DOMINO

Domina todo tipo de sistema con la facilidad de un simple gesto de tocar un objeto de alto diseño.

DOMINO es fácil de usar, gracias a los botones ergonómicos, pequeños (pero no demasiado) y fiables. Puede engancharlo a su llavero o fijarlo en el coche utilizando el sistema de fijación incluido.

Gracias a sus simpáticos accesorios, puede personalizar su mando con un color a elegir entre todos los disponibles. Las carcassas de colores se pueden cambiar en pocos segundos.

DOMINO: la forma más moderna de utilizar la seguridad más avanzada.

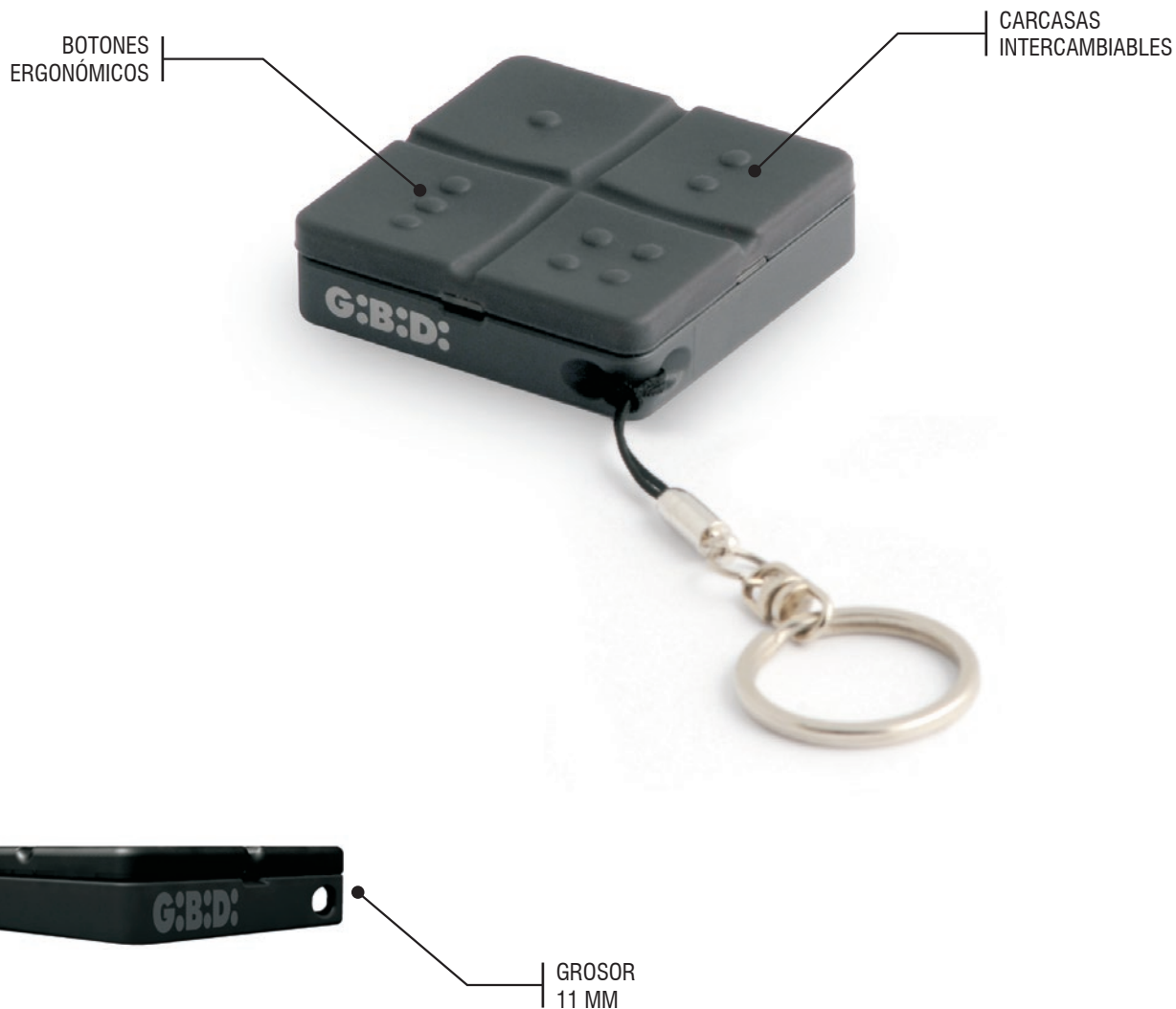



MANAGER

El programador de fácil uso que permite la gestión completa de todas las instalaciones realizadas con dispositivos de la línea MANAGER.

La posibilidad de gestión por ordenador hace que su uso sea aún más simple y sencillo. La solución ofrecida por GIBIDI a todos los que quieran hacer la instalación de propia exclusiva pertinencia.

La programación de los dispositivos se hace en modalidad WIRELESS.

MANAGER permite programar los dispositivos transmisores y receptores, sea de radiofrecuencia o Transponder, gestionando modalidad de funcionamiento, personalizaciones, autorizaciones, modificaciones y también el innovador sistema anticlonación, siempre en modalidad de seguridad (ROLLING-CODE).

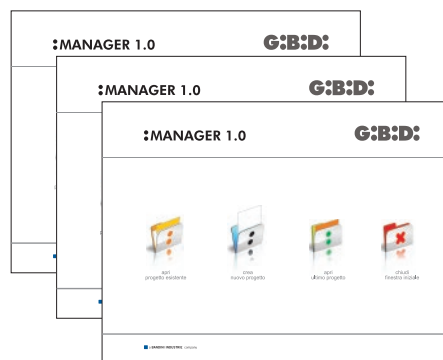



ACCESORIOS.

GIBIDI
CREATIVE AUTOMATIONS

GIOTTO

Para todos aquellos que aman llevar siempre su propio mando, ¡aquí está GIOTTO! El nuevo mando de bolsillo de dos canales y sin bordes. Su tamaño pequeño con teclas grandes hace que sea fácil de usar pero discreto al mismo tiempo.

Equipado con tecnología HPA (Algoritmo de alta protección) que permite utilizarlo con total seguridad.

GIOTTO también es potente y, gracias a las mejores tecnologías, puede abrir y cerrar sus puertas automáticas incluso desde grandes distancias.

GIOTTO es totalmente compatible con las series de Rolling Code MAKO y DOMINO.



GIBIDI
CREATIVE AUTOMATIONS



GIBIDI S.r.l.
Via Abetone Brennero, 177/B
46025 Poggio Rusco (MN) - ITALY
Tel. +39.0386.52.20.11
Fax +39.0386.52.20.31
info@gibidi.com

www.gibidi.com



ACCESORIOS.

GIBIDI
CREATIVE AUTOMATIONS

DSL

Aquí otra pieza de comodidad moderna aplicada, con un diseño inteligente, en una luz externa.

Gracias a la modularidad y a su gran facilidad de instalación, el radio receptor y la antena se integran rápidamente en un solo producto.

Será suficiente elegir el tipo de tarjeta de intermitencia para obtener un producto completo.

Si decide utilizar el receptor en su interior, la memorización de los transmisores estará facilitada por los mandos situados directamente en el contenedor.

DSL: el nuevo signo distintivo de su puerta automática.

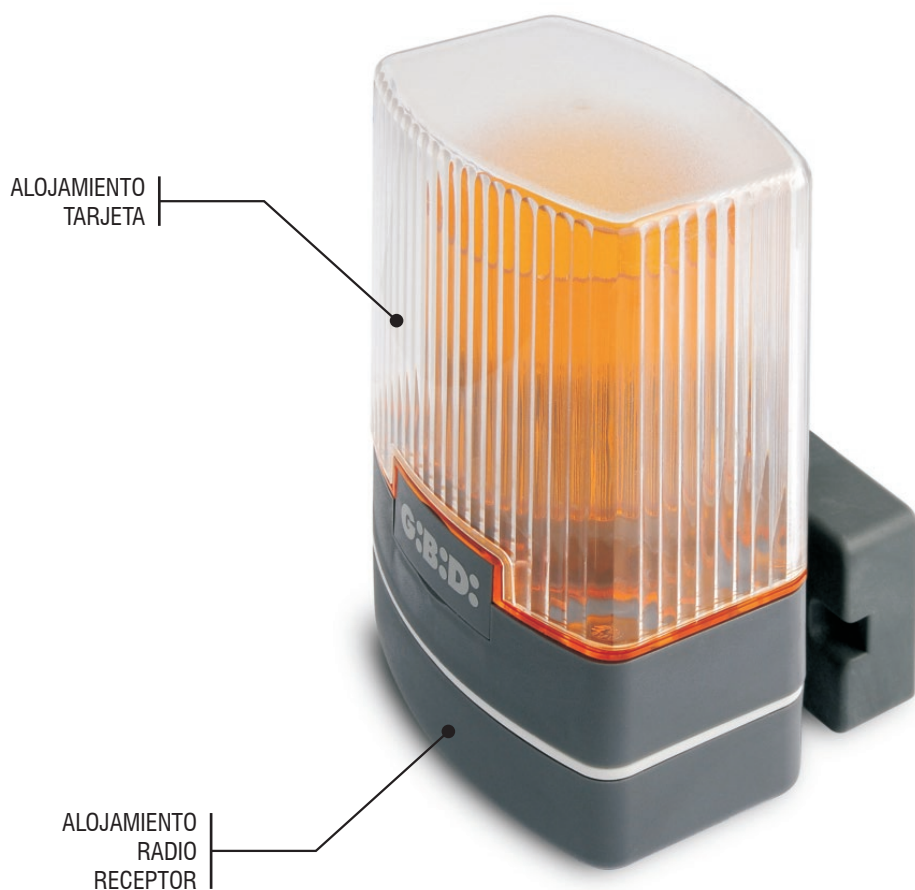

GIBIDI
CREATIVE AUTOMATIONS



GIBIDI S.r.l.
Via Abetone Brennero, 177/B
46025 Poggio Rusco (MN) - ITALY
Tel. +39.0386.52.20.11
Fax +39.0386.52.20.31
info@gibidi.com
www.gibidi.com



ACCESORIOS.

GIBIDI
CREATIVE AUTOMATIONS

DRR

Un nuevo contenedor para receptores de radio apto para la instalación exterior.

Gracias a la gran modularidad es posible efectuar la fijación tanto sobre pared, como sobre columnas o muros.

El paquete incluye el adaptador para poder instalar la antena de exterior directamente en el contenedor.

Un nuevo diseño para un producto simple y funcional.



GIBIDI
CREATIVE AUTOMATIONS



GI.BI.DI. S.r.l.
Via Abetone Brennero, 177/B
46025 Poggio Rusco (MN) - ITALY
Tel. +39.0386.52.20.11
Fax +39.0386.52.20.31
info@gibidi.com
www.gibidi.com



ACCESORIOS.

GIBIDI
CREATIVE AUTOMATIONS

DC

La nueva línea de accesorios GIBIDI, columnitas, fotocélulas y selectores de pared.

Una línea concebida para adaptarse a cualquier exigencia estética y de instalación, un sistema patentado que reúne tecnología, diseño y la practicidad de instalación.

Un sistema sumamente modular que permite una fácil instalación y mantenimiento.

La mejor solución para completar su entrada automática.

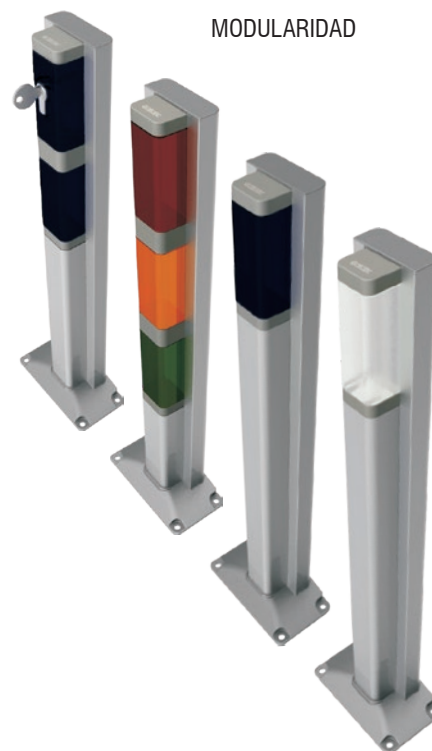
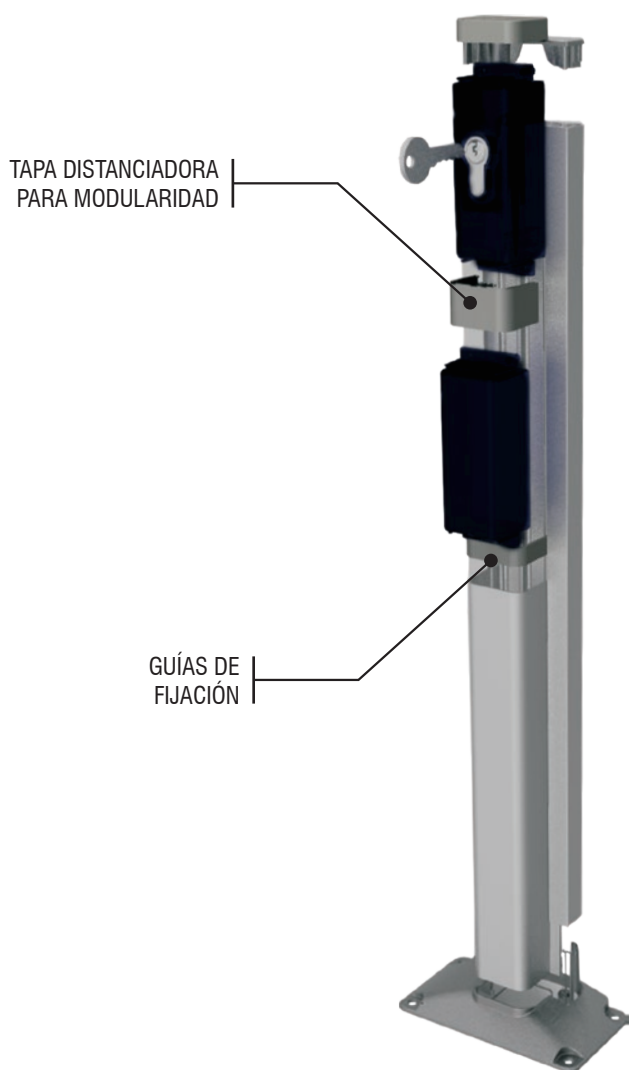

GIBIDI
CREATIVE AUTOMATIONS

G.I.B.I.D.I. S.r.l.
Via Abetone Brennero, 177/B
46025 Poggio Rusco (MN) - ITALY
Tel. +39.0386.52.20.11
Fax +39.0386.52.20.31
info@gibidi.com

www.gibidi.com





DG

La línea de accesorios GIBIDI, columnitas, fotocélulas y selectores, de empotrar o de pared.

Una línea apta para cualquier exigencia de instalación, que encierra tecnología y sencillez de instalación.

Un sistema modular que permite una fácil puesta en marcha y manutención.

Otra solución para completar vuestro ingreso automático.

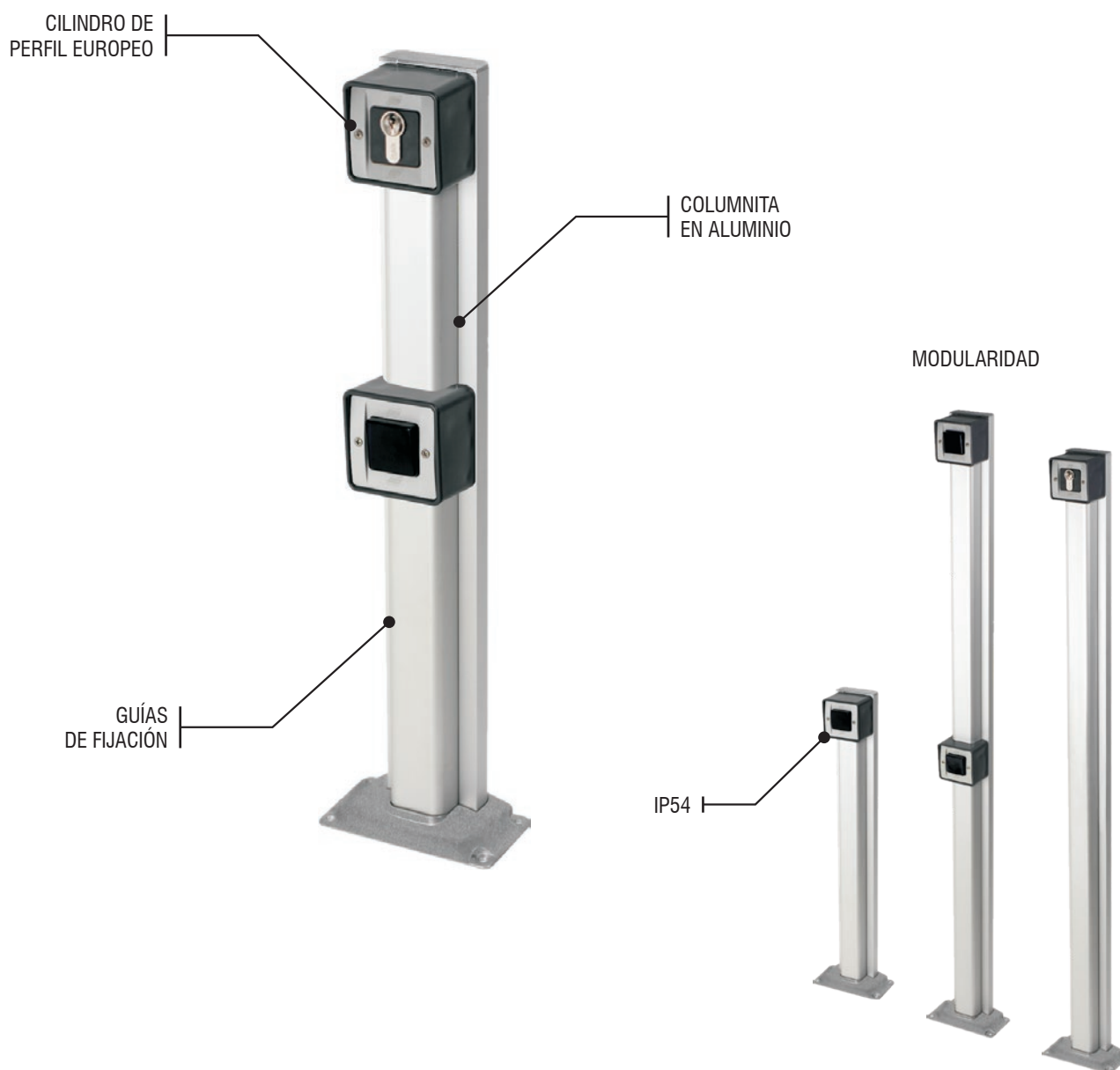



ACCESSOIRES.

G:B:D:
CREATIVE AUTOMATIONS

ACCESSOIRES





ACCESSOIRES.

GIBIDI
CREATIVE AUTOMATIONS

MAKO

Une nouvelle notion d'élégance. Le nouvel émetteur GIBIDI pour ouvrir les portes de votre futur.

Lignes élégantes, boutons ergonomiques et facile à utiliser, LED de signalisation et attache porte-clés inséré directement dans la structure en aluminium robuste moulée sous pression. Boîtier réalisé avec les plus modernes techno-polymères et, à l'intérieur, toute la technologie GIBIDI.

Electronique innovante réalisée avec les plus hauts standards technologiques pour garantir toujours la meilleure fiabilité,

sécurité et puissance du signal, grâce au système HPA (High Protection Algorithm)!

Disponible également avec l'électronique MANAGER pour une gestion des accès évoluée, qui ne peut pas être clonée ! MAKO avec MANAGER, le binôme de la sécurité.

MAKO: Une nouvelle manière d'utiliser les technologies les plus avancées.

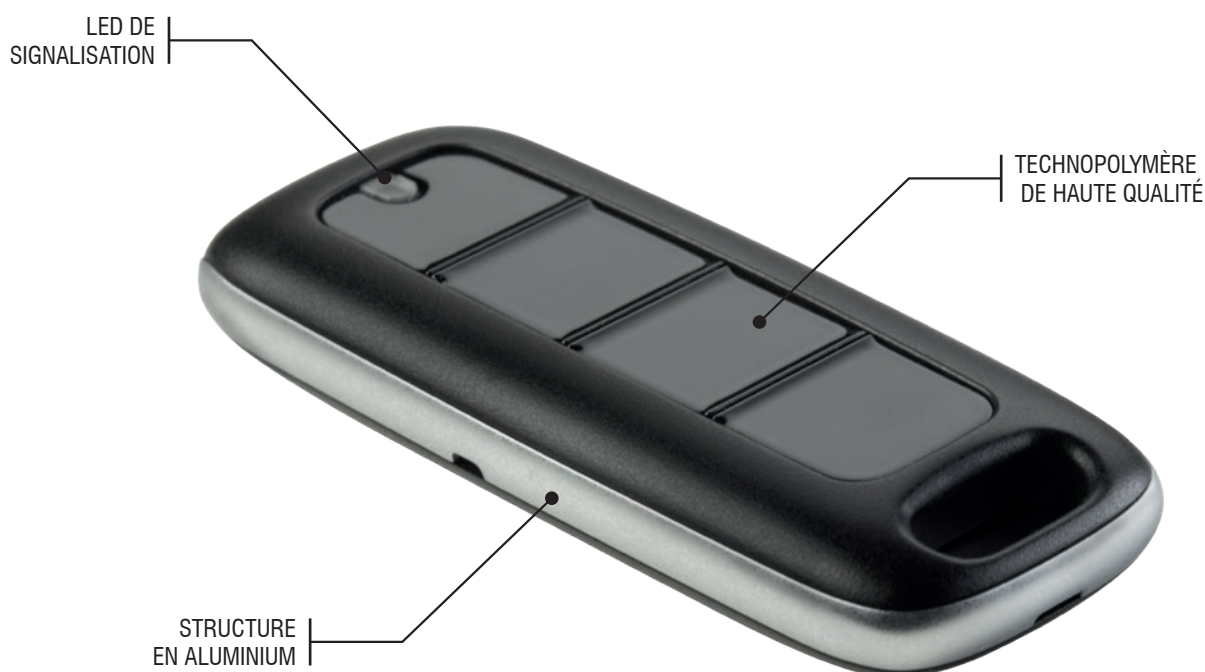

GIBIDI
CREATIVE AUTOMATIONS



GIBIDI S.r.l.
Via Abetone Brennero, 177/B
46025 Poggio Rusco (MN) - ITALY
Tel. +39.0386.52.20.11
Fax +39.0386.52.20.31
info@gibidi.com

www.gibidi.com



DOMINO

Il domine chaque type de système avec la facilité d'un simple geste qui touche un objet de haute conception.

DOMINO est facile à utiliser, grâce aux boutons ergonomiques, petits (mais pas trop) et fiables. Vous pouvez l'attacher à votre porte-clés ou le fixer dans la voiture à l'aide du système de fixation inclus.

Grâce aux beaux accessoires, vous pouvez personnaliser votre radiocommande avec une couleur de votre choix parmi celles disponibles. Les couvertures colorées peuvent être changées en quelques secondes.

DOMINO: la façon la plus moderne d'utiliser la sécurité la plus avancée.

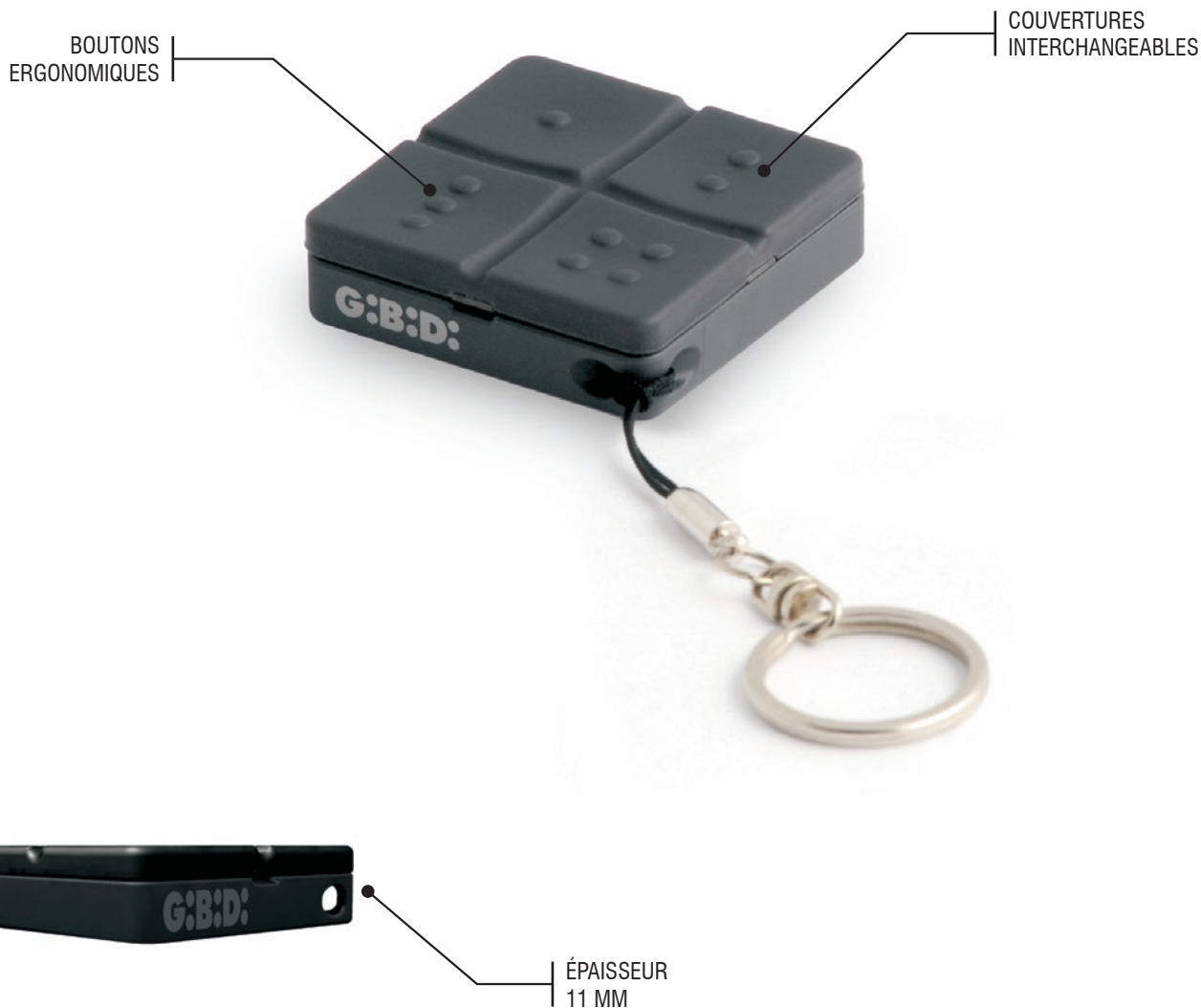



MANAGER

Ce programmeur d'utilisation aisée, permet la gestion complète de toutes les installations réalisées avec les dispositifs de la série MANAGER.

La possibilité de gestion par PC rend son utilisation encore plus simple et conviviale.

Solution offerte par GIBIDI à tous ceux qui désirent maîtriser personnellement leurs installations.

La programmation des dispositifs se fait en mode WIRELESS.

MANAGER permet de programmer des dispositifs émetteurs et récepteurs que ce soit en fréquence radio ou bien avec transponder, gérant toutes les modalités de fonctionnement, la personnalisation, les autorisations, les modifications et même l'innovant système anti-clonage toujours en mode de sécurité (ROLLING-CODE).

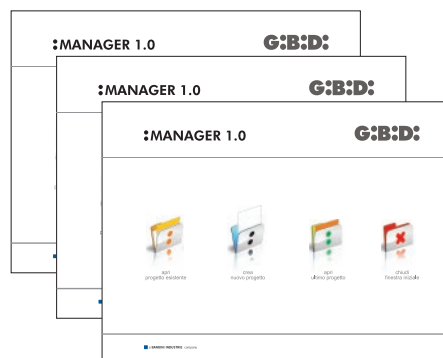



GIOTTO

Pour tous ceux qui aiment toujours avoir leur propre radiocommande, voici GIOTTO! La nouvelle radiocommande de poche à deux canaux sans bords. Sa petite taille avec de grandes touches le rend facile à utiliser mais discret en même temps.

Équipé de la technologie HPA (High Protection Algorithm), il peut être utilisé en toute sécurité.

GIOTTO est également puissant et grâce aux meilleures technologies, il est capable d'ouvrir et de fermer votre portail automatique même à grande distance.

GIOTTO est entièrement compatible avec les séries de Rolling Code MAKO et DOMINO.





DSL

Voici autre aspect de l'agréable modernité appliquée, avec intelligence de conception, à un clignotant.

Grâce à la modularité et à l'extrême facilité d'installation, le récepteur radio et l'antenne s'intègrent rapidement en un seul produit.

Il suffira de choisir le type de carte de clignotant pour obtenir un produit complet.

Si vous décidez d'utiliser le récepteur radio à l'intérieur, la mémorisation des émetteurs sera facilitée par les commandes placées directement sur le boîtier.

DSL: Le nouveau signe particulier de votre portail automatique.

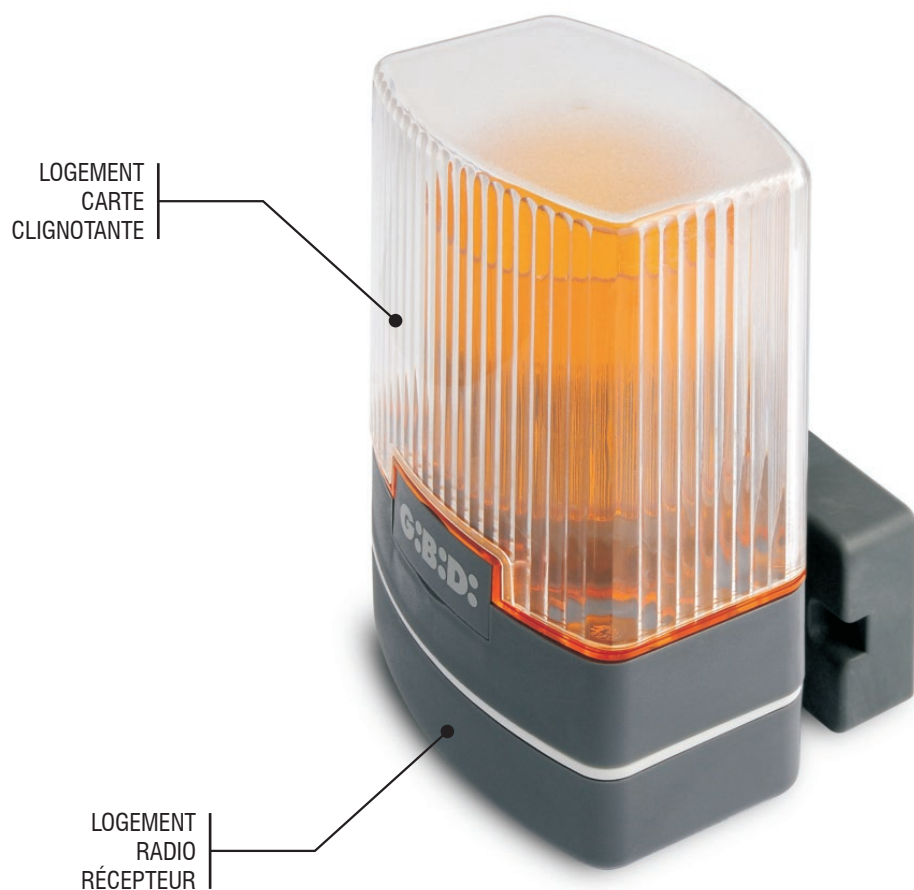



ACCESSOIRES.

GIBIDI
CREATIVE AUTOMATIONS

DRR

Un nouveau boîtier pour récepteurs radio adapté pour des installations extérieures.

Grâce à l'extrême modularité, il est possible d'effectuer la fixation sur des piliers ou des murs.

Dans la confection, on trouve l'adaptateur pour pouvoir installer l'antenne d'extérieur directement sur le boîtier.

Un nouveau design pour un produit simple et fonctionnel.



GIBIDI
CREATIVE AUTOMATIONS



GIBIDI S.r.l.
Via Abetone Brennero, 177/B
46025 Poggio Rusco (MN) - ITALY
Tel. +39.0386.52.20.11
Fax +39.0386.52.20.31
info@gibidi.com
www.gibidi.com



DC

Nouvelle ligne d'accessoires GIBIDI, colonnes, photocellules et sélecteurs à poser en applique.

Une ligne conçue pour s'adapter à toute exigence d'installation et d'esthétique, un système breveté qui réunit: technologie, design et commodité d'installation.

Un système extrêmement modulaire, qui facilite la mise en oeuvre et la maintenance.

La solution rationnelle pour compléter votre accès automatisé.

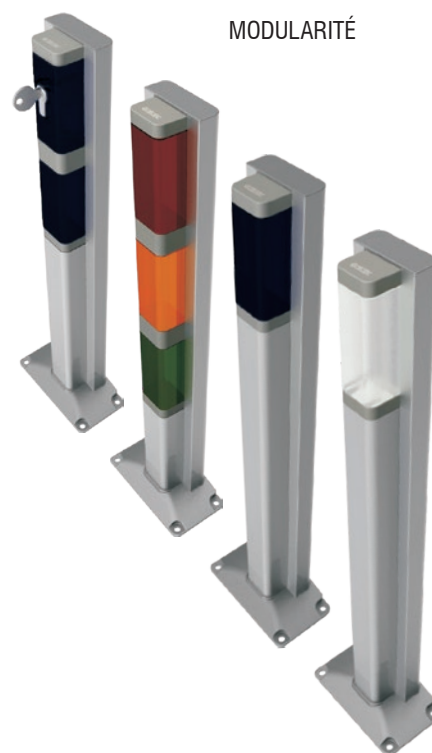
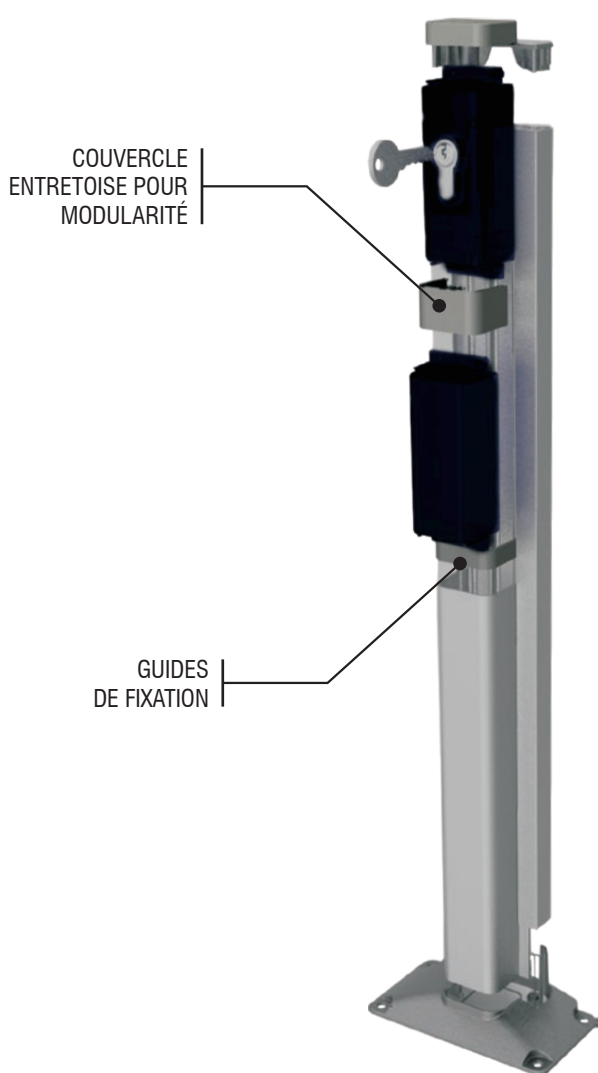



ACCESSOIRES.

GIBIDI
CREATIVE AUTOMATIONS

DG

Ligne d'accessoires GIBIDI, colonnes, photocellules et sélecteurs, encastrables et en applique.

Une ligne adaptable à toute exigence d'installation, qui réunit technologie et commodité d'installation.

Un système modulaire, qui facilite la mise en oeuvre et la maintenance.

Une solution ultérieure pour compléter et sécuriser votre accès automatisé.

CYLINDRE
PROFIL EUROPEEN

GUIDES
DE FIXATION

COLONNE
EN ALUMINIUM

MODULARITÉ

IP54



GIBIDI
CREATIVE AUTOMATIONS

G.I.B.I.D.I. S.r.l.
Via Abetone Brennero, 177/B
46025 Poggio Rusco (MN) - ITALY
Tel. +39.0386.52.20.11
Fax +39.0386.52.20.31
info@gibidi.com
www.gibidi.com





ZUBEHÖR.

G:B:D:
CREATIVE AUTOMATIONS

ZUBEHÖR





ZUBEHÖR.

GIBIDI
CREATIVE AUTOMATIONS

MAKO

Ein neues Konzept von Eleganz, das neue GIBIDI-Handsender, um die Türen zu Ihrer Zukunft zu öffnen. Elegante Leisten, ergonomische und benutzerfreundliche Tasten, Signalleads und Aufhängung für den Schlüsselanhänger, der direkt aus dem Kern aus robustem Aluguss hergestellt wird. Schale aus modernsten Technopolymeren und innen, alle GIBIDI-Technologien.

Innovative Elektronik mit den höchsten technologischen Standards, die dank des HPA-Systems (High Protection

Algorithm) stets Zuverlässigkeit, Sicherheit und Signalstärke garantiert!

Auch mit MANAGER-Elektronik für erweitertes und nicht klonbares Zugriffsmanagement erhältlich! MAKO mit MANAGER, dem Binomial der Sicherheit.

MAKO: Die neue Art, modernste Technologie einzusetzen.



GIBIDI
CREATIVE AUTOMATIONS



GIBIDI S.r.l.
Via Abetone Brennero, 177/B
46025 Poggio Rusco (MN) - ITALY
Tel. +39.0386.52.20.11
Fax +39.0386.52.20.31
info@gibidi.com

www.gibidi.com



ZUBEHÖR.

GIBIDI
CREATIVE AUTOMATIONS

DOMINO

Es beherrscht jede Art von System mit der Leichtigkeit einer einfachen Geste, die ein Objekt mit hohem Design berührt.

DOMINO ist dank der ergonomischen Tasten einfach zu bedienen, klein (aber nicht zu viel) und zuverlässig. Sie können es an Ihrem Schlüsselring befestigen oder mit dem mitgelieferten Befestigungssystem im Auto befestigen.

Dank des netten Zubehörs können Sie Ihre Funksteuerung mit einer Farbe Ihrer Wahl aus den verfügbaren anpassen. Die farbigen Abdeckungen können in Sekunden geändert werden.

DOMINO: Die modernste Art, die fortschrittlichste Sicherheit zu nutzen.

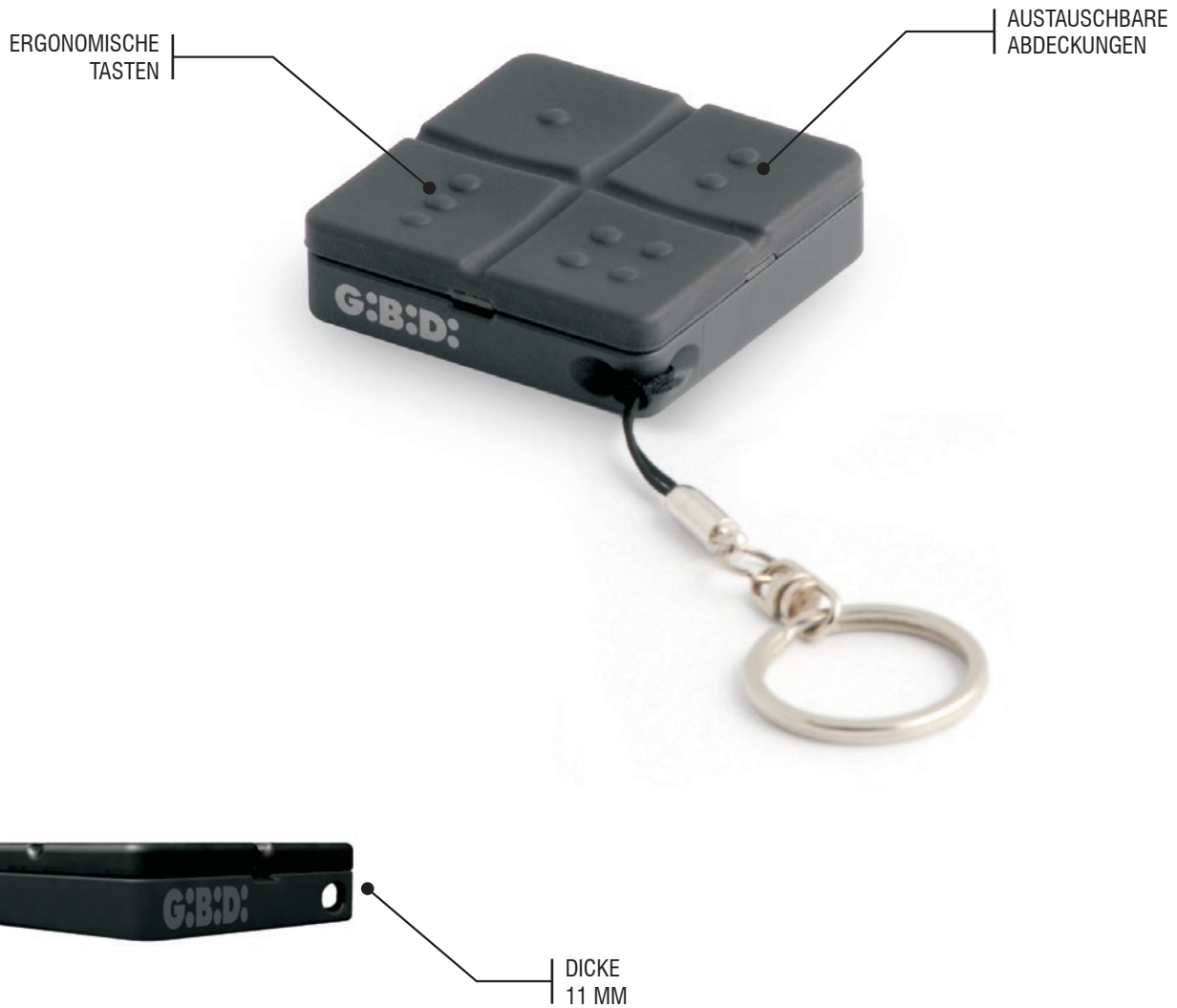

GIBIDI
CREATIVE AUTOMATIONS



G.I.B.I.D.I. S.r.l.
Via Abetone Brennero, 177/B
46025 Poggio Rusco (MN) - ITALY
Tel. +39.0386.52.20.11
Fax +39.0386.52.20.31
info@gibidi.com
www.gibidi.com



MANAGER

Der benutzerfreundliche Programmierer, der die vollständige Verwaltung aller Systeme ermöglicht, die mit Geräten der MANAGER-Serie gebaut wurden.

Die Möglichkeit der Verwaltung über den PC macht die Verwendung noch einfacher und attraktiver.

Die von GIBIDI angebotene Lösung für alle, die das System zu ihrem eigenen exklusiven Eigentum machen möchten.

Die Programmierung der Geräte erfolgt im WIRELESS-Modus.

Mit MANAGER können Sie sowohl Funkfrequenz- als auch Transponder-Sender- und Empfangsgeräte programmieren, Betriebsmode, Anpassungen, Berechtigungen, Modifikationen sowie das innovative Anti-Klon-System immer im Sicherheitsmodus (ROLLING -CODE) verwalten.

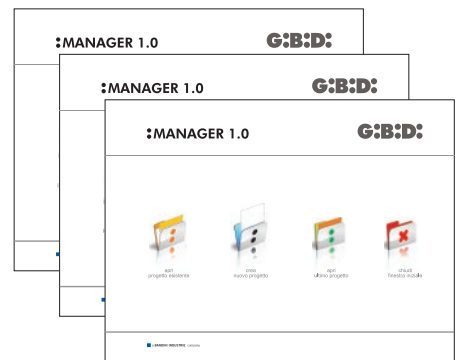



ZUBEHÖR.

GIBIDI
CREATIVE AUTOMATIONS

GIOTTO

Für alle die gerne ihre eigene Handsender immer bei sich zu haben möchten, da ist GIOTTO! Die neue Zweikanal-Taschenfunksteuerung ohne Kanten. Seine geringe Größe mit großen Tasten macht es einfach zu bedienen, aber gleichzeitig diskret.

Ausgestattet mit der HPA-Technologie (High Protection Algorithm) es kann absolut sicher eingesetzt werden.

GIOTTO ist auch leistungsstark und kann dank der besten Technologien Ihr automatisches Tor auch aus großer Entfernung öffnen und schließen.

GIOTTO ist vollständig kompatibel mit den Rolling-Code-Serien MAKO und DOMINO.heit zu nutzen.



GIBIDI
CREATIVE AUTOMATIONS



GIBIDI S.r.l.
Via Abetone Brennero, 177/B
46025 Poggio Rusco (MN) - ITALY
Tel. +39.0386.52.20.11
Fax +39.0386.52.20.31
info@gibidi.com

www.gibidi.com



ZUBEHÖR.

GIBIDI
CREATIVE AUTOMATIONS

DSL

Noch eine Freude an moderner Technologie und intelligentem Design auf eine Blinkleucht angewendet.

Dank seiner Modularität und extrem einfachen Installation kann der Funkempfänger und Antenne schnell in einem integriertem Produkt.

Alles was Sie tun müssen, ist die Art der Blinkleucht und Ihre zu wählen Produkt ist vollständig.

Wenn Sie sich für den eingebauten Funkempfänger entscheiden, können Sie den speichern Sender einfach über die Bedienelemente am Gehäuse.

DSL: das neue Markenzeichen Ihres automatischen Tors.

ELEKTRONISCHES
PLATINEGEHÄUSE

RADIOEMPFÄNGERGEHÄUSE



GIBIDI
CREATIVE AUTOMATIONS



GIBIDI S.r.l.
Via Abetone Brennero, 177/B
46025 Poggio Rusco (MN) - ITALY
Tel. +39.0386.52.20.11
Fax +39.0386.52.20.31
info@gibidi.com
www.gibidi.com



ZUBEHÖR.

GIBIDI
CREATIVE AUTOMATIONS

DRR

Ein neues Gehäuse für Funkempfänger für den Außenbereich Installation.

Dank der extremen Modularität kann es an der Wand montiert werden oder säulenmontiert.

Das Kit enthält einen Adapter zur Installation der Außenantenne direkt auf den Fall.

Ein neues Design für ein einfaches und funktionales Produkt.



GIBIDI
CREATIVE AUTOMATIONS



GIBIDI S.r.l.
Via Abetone Brennero, 177/B
46025 Poggio Rusco (MN) - ITALY
Tel. +39.0386.52.20.11
Fax +39.0386.52.20.31
info@gibidi.com
www.gibidi.com



ZUBEHÖR.

GIBIDI
CREATIVE AUTOMATIONS

DC

Das neue Sortiment an GIBIDI Zubehör, Säulen, Lichtschranken und an der Wand montierte Schlüsselwähler.

Ein Sortiment, das an jede Art von Installation angepasst werden kann oder ästhetische Anforderung, ein patentiertes System, das umfasst Technologie, Design und einfache Installation.

Ein modulares System, das eine einfache Einrichtung und Wartung ermöglicht.

Die perfekte Lösung, um Ihren automatischen Eingang zu vervollständigen.

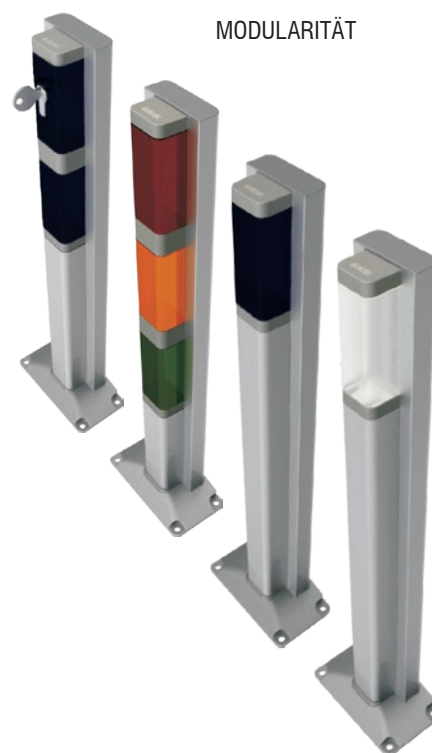
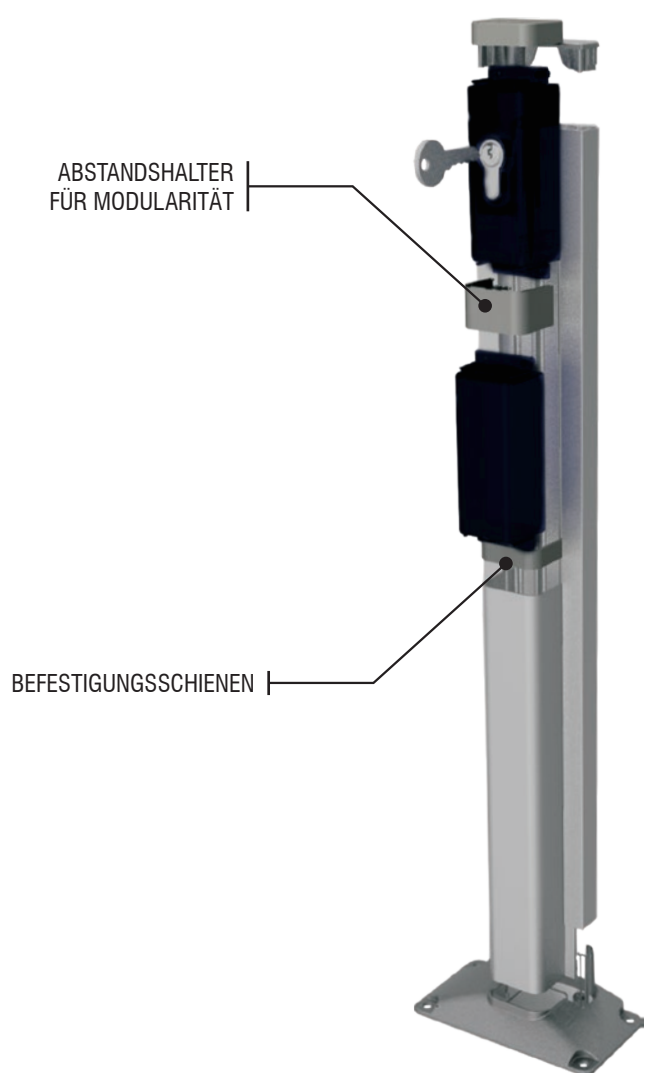

GIBIDI
CREATIVE AUTOMATIONS

G.I.B.I.D.I. S.r.l.
Via Abetone Brennero, 177/B
46025 Poggio Rusco (MN) - ITALY
Tel. +39.0386.52.20.11
Fax +39.0386.52.20.31
info@gibidi.com

www.gibidi.com





ZUBEHÖR.

GIBIDI
CREATIVE AUTOMATIONS

DG

Das Sortiment an GIBIDI-Zubehör, Säulen, Lichtschranken und Einbauten oder an der Wand montierte Schlüsselwähleschalter.

Ein Bereich, der an jede Art von Installation angepasst werden kann Anforderung, die Technologie und einfache Installation umfasst.

Ein modulares System, das eine einfache Einrichtung und Wartung ermöglicht.

Eine weitere Lösung, um Ihren automatischen Eingang zu vervollständigen.

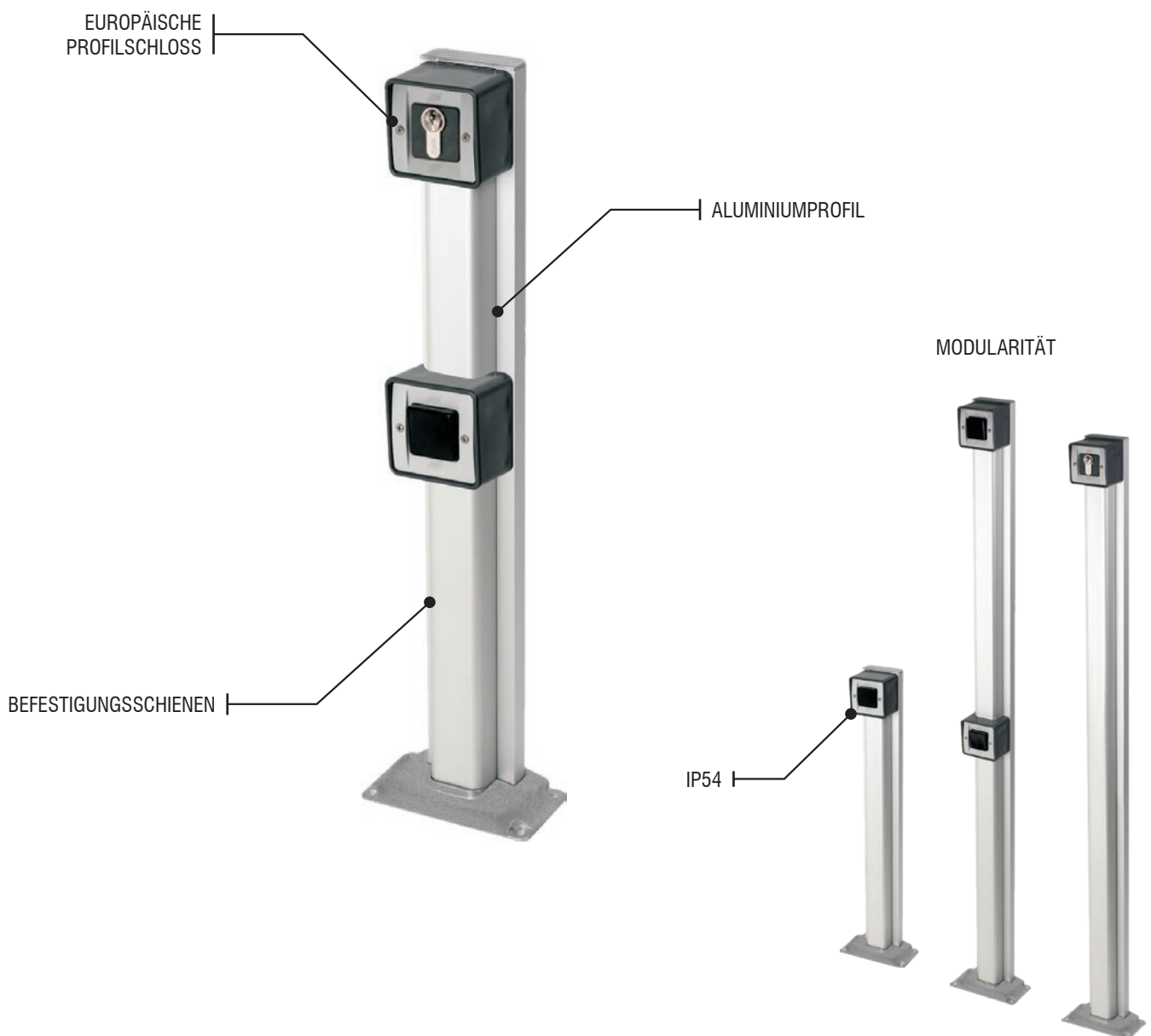

GIBIDI
CREATIVE AUTOMATIONS

G.I.B.I.D.I. S.r.l.
Via Abetone Brennero, 177/B
46025 Poggio Rusco (MN) - ITALY
Tel. +39.0386.52.20.11
Fax +39.0386.52.20.31
info@gibidi.com
www.gibidi.com

